

HIGH-QUALITY VEHICLE TECHNOLOGY

FOR MOTORHOMES, VANS & CARAVANS



- ✓ State-of-the-art technology and accessory products
- ✓ High-quality workmanship guarantees reliability and durability
- ✓ Tested and proven by professionals for years
- ✓ Fair and attractive price-performance ratio
- ✓ 3 years warranty on all Carbest products

CARBEST

QUALITY & RELIABILITY FOR OVER 20 YEARS.

Since 2000, Carbest has stood for high-quality technology products for motorhomes and campervans. What began with inverters and driver's cab accessories for retrofitting is now a global brand with an extensive range of products.

Carbest's motorhome chargers, LED lights, lithium batteries and camping satellite systems are now also used by many brands as original equipment.

In order to offer the Carbest range with a particularly attractive price/performance ratio, the products are manufactured directly in specialised factories and sourced without any other intermediaries. This makes it possible to achieve high quality prices without compromising the quality of the products.

Carbest products are specially developed with the aim of being used in high quality motorhomes, campervans or caravans. For example, Carbest's 12 V chargers are equipped with temperature-controlled fans, because nobody likes to sleep near a loud fan. With chargers from the car or workshop sector, on the other hand, the volume of the fan is usually not a factor. For this reason, it is possible to save on this important function when camping

Extensive tests in the development department in Germany by engineers, technicians and experienced camping professionals ensure that the quality of the Carbest products and their functions are ideal for mobile use in the camping area

Now, Reimo's 40 years of experience in the development and manufacture of campervans flow into the development of the products. Special attention is paid to the quality and functions of all products so that they are not only fun to use when camping, but also meet the high demands of the components used in motorhome production.

Carbest 12 V camping TVs, for example, are equipped with special mainboards equipped with special mainboards which are reinforced against vibration while driving

Conventional household TV sets that come with a 12V plug would be much cheaper to manufacture, but don't offer the longevity that true camping TVs do.

Carbest's sine wave inverters are specifically designed to power air conditioners and capsule coffee makers in Motorhomes. And because we know that not only the product but also the installation is decisive for the use, with Carbest inverters already come with the cables for connecting to the 12V battery, of course with professional cable cross-sections and 2 m length.

Warranty:

The warranty period is 36 months. Reimo reserves the right to rectify possible faults. The warranty is excluded for any damage caused by incorrect use or improper handling. Limitations of liability: In no event shall Reimo be liable for incidental, consequential or indirect damages, costs, expenses, loss of use or loss of profits. The stated selling price of the product represents the appropriate amount of Reimo's limitation of liability.

© Copyright by Reimo GmbH Egelsbach:

All information in this catalogue without guarantee. All rights, errors and changes reserved. Illustrations partly show extras and decorations which are not included in the scope of delivery. Reprinting and use in electronic media, including excerpts, only with the express permission of Reimo GmbH, Boschring 10, 63329 Egelsbach

Status: February 2021.

www.carbest.de



CONTENTS

Flexible solar panels	4
Flexible solar panel complete kits	5
Rigid solar panels	7
Rigid solar panel complete kits	8 - 9
Foldable solar panels + solar accessories	10 - 11
Lithium (LiFePO4) Batteries	12 - 13
Energy-Station / Battery Chargers	14 - 15
Inverter	15 - 17
Widescreen TVs + Smart TVs	18 - 19
TV Wall Mounts	20
Satellite Systems	21 - 29
Rear view cameras + monitors	31 - 35
Compressor coolers	36 - 39
Absorption coolers	39
Built-in compressor refrigerators	40 - 41
Fans / 230 V heaters	44
Sliding windows/real glass windows	44 - 50
Inner frame for RW window series	51
Roof lights	52 - 53
12V LED line lights	54
12V LED superstructure/aperture lights	55
12V LED lights with night light	56

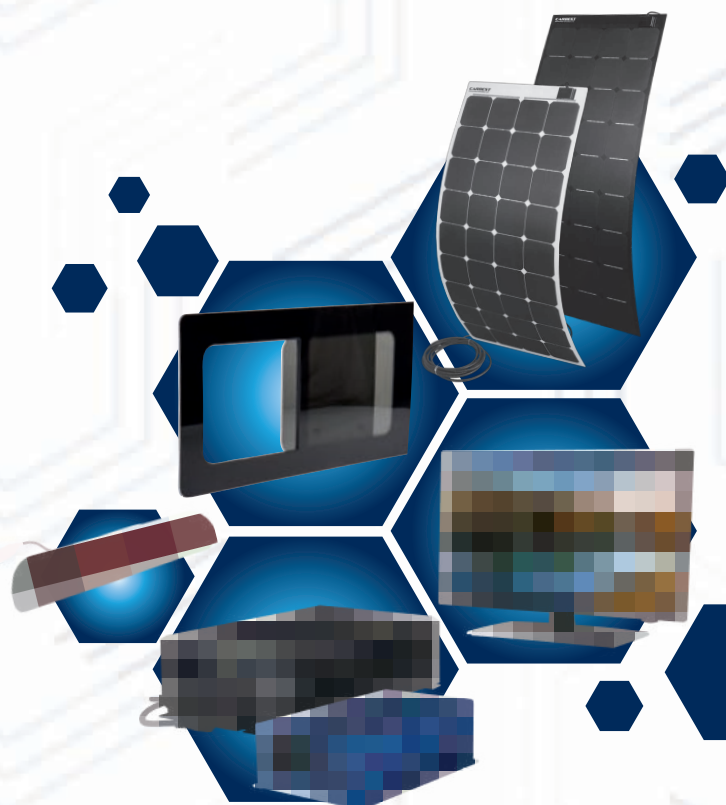

12V LED flex lights and spotlights	57
12V SMD and COB light source	58
Outdoor lights with battery	58
LED/COB multifunctional lights	59
Aluminium profiles for LED flex strips	60
12V LED flexstrips	61
Gas detectors + smoke detectors + safes	62
CEE plugs, cables, cable drums	63 - 64
Schuko accessories for 230 V	65
Trailer electrics	66
Cara-Move manoeuvring systems + Lifting supports fully automatic	67
Step wedges + steps	68 - 69
Multifunctional ladders	70
Practical accessories for vehicle and household	68 - 72
X-Trem® vehicle insulation	73
Roller doors + water pumps	74
Exhaust hood + vehicle protection	75



ULTRA-FLEXIBLE HIGH-PERFORMANCE SOLAR PANELS FROM 80 TO 160 WATT

- Sunpower cells: Significant increase in power output even at a less than optimal angle to the sun
- Only 3 mm thin!
- Approx. 5 x lighter than conventional modules
- Can be walked on when glued over a wide area
- Compact connection with pre-installed 8 m cable (2 x 2.5 mm²)
- High-quality ETFE surface
- Also ideal for maritime use

The solar panels deliver more power than conventional PV modules of the same size. Thanks to the high-quality ETFE surface with honeycomb structure, there is a clear increase in performance in twilight and cloudy conditions. The special back-contact technology of the solar cells enables bending radii of up to 20°

Especially at high temperatures, the performance is significantly higher than that of comparable modules. This means maximum efficiency without a drop in performance. The pre-assembled solar cable shortens installation time and, at 8 m long, is also sufficient for large vehicles. The above-average bending capacity also makes the Carbest modules ideal for maritime applications.

Material cover layer:

ETFE: Very hard and thin (approx. 0.025 mm) material with high light transmission of approx. 95%. Heat resistant up to approx. 150°C. Very high weather resistance, also suitable for salt water.

Material carrier plate:

TPT: Material with high bending capacity. More flexible than fiberglass.

Fiberglass: Very strong, hard material for the best possible protection of the solar cells

Mounting instructions:

All Flex panels must be glued over the entire surface (without air pockets). Subsequently, all module edges must be completely sealed up to the top cover layer.



Ideal for vans and motorhomes. Ensures consistent driving performance.

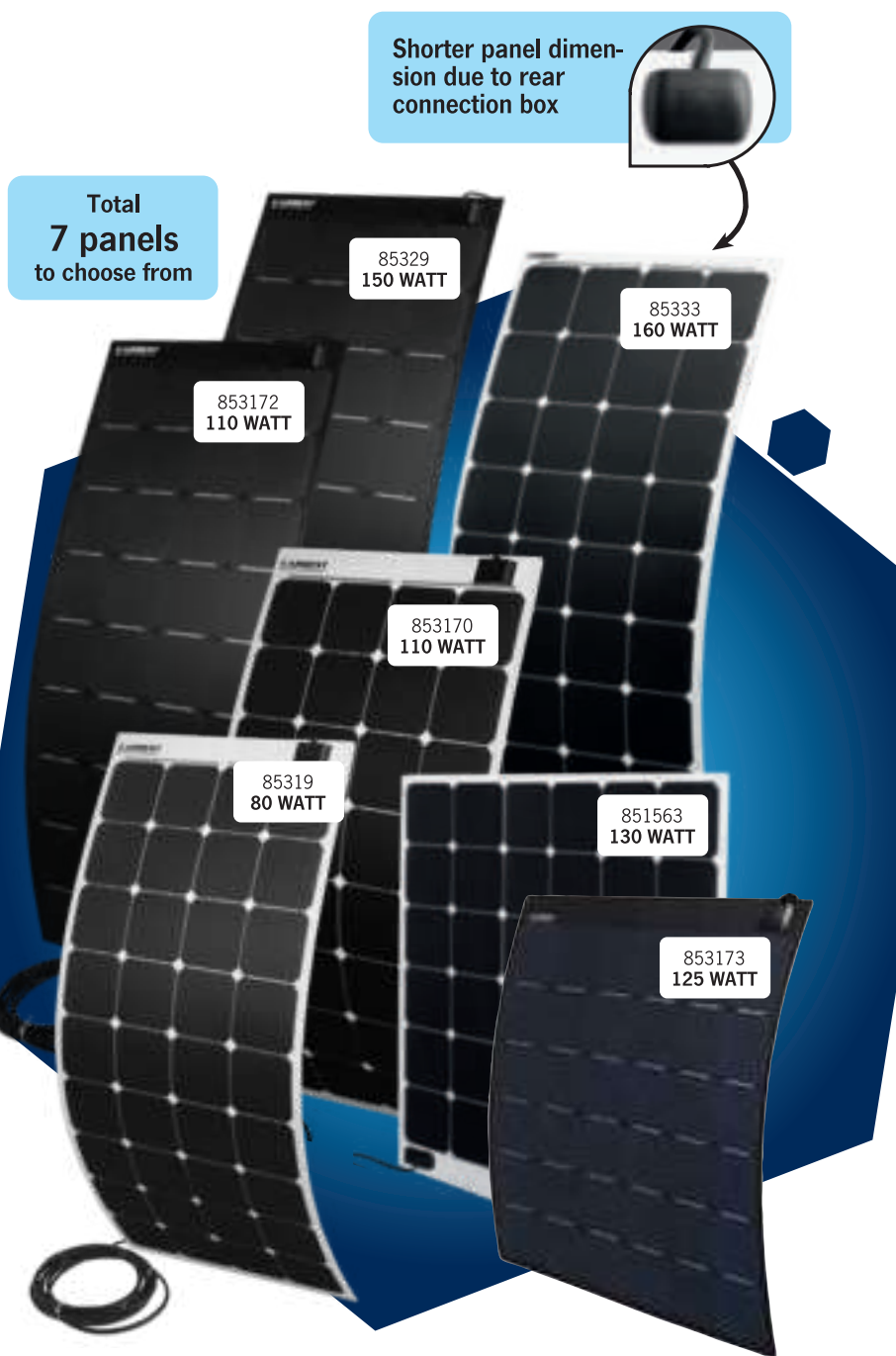

	Power Panel Flex 80 white*	Power Panel Flex 110 Pro black	Power Panel Flex 110 white	Power Panel Flex 125 Square black	Power Panel Flex 130 Square white*	Power Panel Flex 150 Pro black*	Power Panel Flex 160 white*
Power / Number of cells	80 W/56 cells	110 W/32 cells	110 W/32 cells	125 W/36 cells	130 W/36 cells	150 W/44 cells	160 W/44 cells
Material top layer	ETFE	ETFE	ETFE	ETFE	ETFE	ETFE	ETFE
Material carrier plate	TPT	Fiberglass	TPT	Fiberglass	TPT	Fiberglass	TPT
Efficiency	20,8 %	22,5 %	22,6 %	22,5 %	23,7 %	22,6 %	23,7 %
Short circuit current (Isc)	2,8 A	6,88 A	6,32 A	6,94 A	6,37 A	6,32A	6,18 A
Open circuit voltage (Voc)	36.5 Volt	20.77 Volt	21.9 Volt	23.36 Volt	25.42 Volt	30.1 Volt	32.2 Volt
Rated voltage (Vmp)	30.8 Volt	17.6 Volt	18.6 Volt	19.8 Volt	21.6 Volt	25.5 Volt	27.3 Volt
Rated current (Imp)	2,6 A	6,25 A	5,97 A	6,31 A	6,01 A	5,97 A	5,83 A
Dimensions mm LxWxH (Box H)	980 x 550 x 3 (22)	1100 x 540 x 2,5 (22)	1095x540x3 (22)	840x800x2,5 (22)	860 x 800 x 3 (22)	1475 x 540 x 3 (22)	1460 x 540 x 3 (22)
Cable (2 x 2.5 mm ²)	8 m	8 m	8 m	8 m	8 m	8 m	8 m
Weight incl. cable	approx. 2,1 kg	approx. 4.0 kg	approx. 3,2 kg	approx. 4,3 kg	approx. 3.9 kg	approx. 5,6 kg	approx. 4.8 kg
Item no.	85319	853172	853170	853173	851563	85329	85333
Price	229,-	309,-	289,-	349,-	337,-	469,-	459,-

*We recommend an MPPT charge controller (e.g. 851005 or 851006)

COMPLETE SOLAR KITS WITH THE ULTRA-FLEXIBLE HIGH-PERFORMANCE SOLAR PANELS FROM 80 TO 160 WATT



Total
7 sets
to choose from

- Kits include solar panel with pre-installed 8m cable, high quality MPPT charge controller, roof feed through,
- Power from 80 to 160 Watt

Complete kit Power Panel Flex 80 white Ideal for devices with hidden power drains and for low energy demand. e.g. for mobile phone charging and other USB devices such as battery packs or cameras, light and water pump, battery maintenance and compensation of silent consumers

Complete kit Power Panel Flex 110-130 white or black Kit with the Carbest 130 W solar panel. For example for light, water pump, compressor cooler, occasionally heating

Complete kit Power Panel Flex 150/160 white or black Kit with the Carbest 150/160 W solar panel. e.g. E.g. for light, pump, TV/Sat, heating and compressor fridge

All kits included for gel, AGM, acid or LiFePO4 batteries (battery type adjustable).

Mounting Notice:

All flex panels must be fully glued (without air pockets). Subsequently, all panel edges must be completely sealed up to the top cover layer.

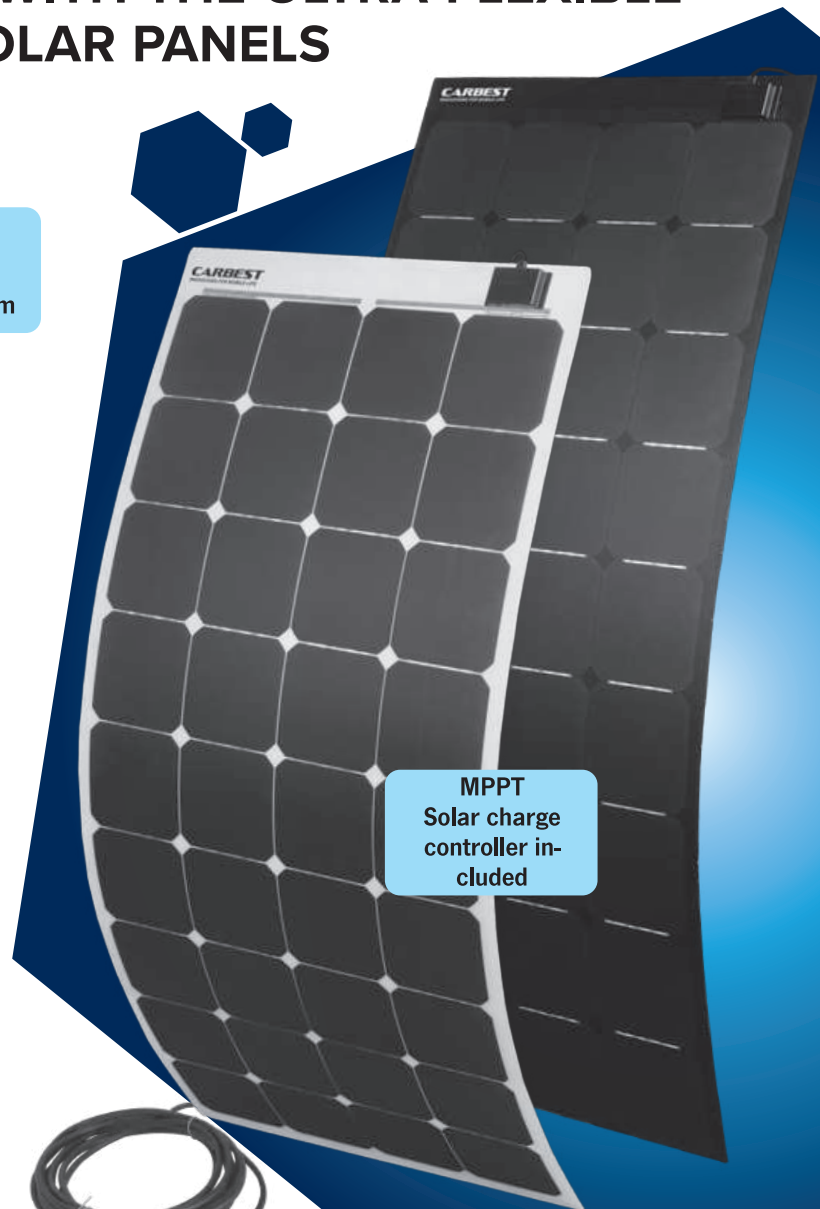

MPPT
Solar charge
controller in-
cluded

Structure of the Carbest ultraflexible solar panels

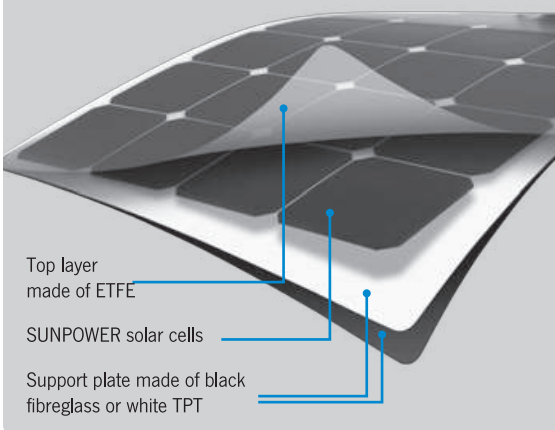

	Complete kit Power Panel Flex 80 white	Complete kit Power Panel Flex 110 Pro black	Complete kit Power Panel Flex 110 white	Complete kit Power Panel Flex 125 Square black	Complete kit Power Panel Flex 130 Square white	Complete kit Power Panel Flex 150 Pro black	Complete kit Power Panel Flex 160 white (rear connection box)
Solar panel power	80 W	110 W	110 W	125 W	130 W	150 W	160 W
Solar panel	1 x 85319	1 x 853172	1 x 853170	1 x 853173	1 x 851563	1x 85329	1x 85333
Cable (2 x 2.5 mm ²)	8 m preinstalled	8 m preinstalled	8 m preinstalled	8 m preinstalled	8 m preinstalled	8m preinstalled	8m preinstalled
MPPT solar charge controller	851005**	851005**	851005**	851005**	851005**	851005**	851006**
Controller power	165 W	165 W	165 W	165 W	165 W	165 W	350 W
Cable gland	85201	85201	85201	85201	85201	85201	85201
Item no.	85270	85271	85272	85273	85274	85275	85276
Price	299,-	379,-	369,-	439,-	419,-	549,-	529,-

*Bluetooth module for MPPT solar charge controller 851005/851006

Display of relevant solar data on the smartphone via Bluetooth.

Cable length: 3 m

851007

34,90

*MPPT solar charge controller and Bluetooth module available from March 2021.

ENJOY THE SUN.

ENERGY FUEL

WITH THE CARBEST
HIGH PERFORMANCE
SOLAR MODULES.



HIGH PERFORMANCE SOLAR PANELS WITH ALUMINIUM FRAME FROM 100 TO 140 WATT

- Solid aluminium frame (CB series: Silver)
- (Full Black Series: Coated Black)
- Monocrystalline cells
- Tempered glass
- Protected connection with 1m cable (2x 2.5 mm²)
- Power: 100 to 140 Watt
- 25 years power guarantee (After 25 years still 80% power)

Total
7 modules
to choose from

CB-100 Slim
with slim
Design

	CB-100	CB-100 Slim (slim Design)	100W Full-Black	CB-120	120W Full-Black	CB-140	140W Full-Black
Power / Number of cells	100 W/36 cells	100 W/36 cells	100 W/36 cells	120 W/36 cells	120 W/36 cells	140 W/36 cells	140 W/36 cells
Efficiency	20,2%	18,5%	20,7%	20,2%	20,7%	20,2%	20,7%
Short circuit current (Isc)	5,83 A	5,66 A	5,85 A	6,6 A	6,63 A	7,75 A	7,77 A
Open circuit voltage (Voc)	22.82 Volt	22.74 Volt	22.8 Volt	23.51 Volt	23.47 Volt	23.3 Volt	23.28 Volt
Rated voltage (Vmp)	18.35 Volt	18.94 Volt	18.32 Volt	19.43 Volt	19.39 Volt	19.26 Volt	19,21 Volt
Rated current (Imp)	5,45 A	5,28 A	5,46 A	6,18 A	6,19 A	7,27 A	7,29 A
Dimensions in mm LxWxH	1200x545x35	1580x410x35	1200x545x35	1400x545x35	1400x545x35	1640x545x35	1640x545x35
Weight	approx. 7,5 kg	approx. 7,5 kg	approx. 7,5 kg	approx. 9.0 kg	approx. 9.0 kg	approx. 10,5 kg	approx. 10,5 kg
Art. No.	85226	85285	85229	85227	85239	85250	85240
Price	179,-	189,-	199,-	219,-	229,-	239,-	259,-

COMPLETE SOLAR KITS FROM 100 TO 240 WATT

- Kits include solar panel(s) with mounting bracket, roof gland MPPT solar charge controller and 10 m solar cable (All sets with MPPT solar charge controller except starter set)
- Monocrystalline cells. Silver, solid aluminium frame
- Tempered glass
- With pre-installed 1 m connection cable (2x 2.5 mm²)
- 25 years performance guarantee (After 25 years still 80% power)

All kits incl. bracket, Charge controller, roof guide Guide incl. 10m cable

MPPT Solar charge controller inclusive (except starter set)

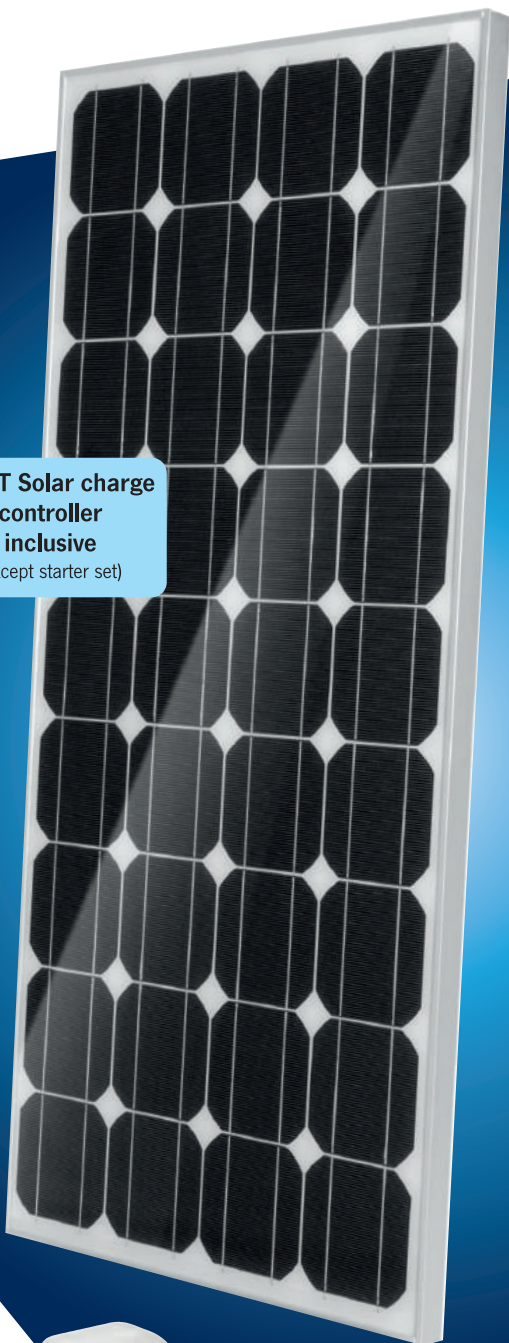

	Starter complete kit CB-100B (without MPPT solar charge controller)	Complete kit CB-100	Complete kit CB-100 Slim	Complete kit CB-120	Complete kit CB-140	Complete kit CB-200	Complete kit CB-240
Solar module power	1x 100 W	1x 100 W	1x 100 W	1x 120 W	1x 140 W	2x 100 W	2x 120 W
Solar module	1x 85226	1x 85226	1x 85285	1x 85227	1x 85250	2x 85226	2x 85227
Charge controller	85135	851005	851005	851005	851005	851006	851006
Controller power	180 W	165 W	165 W	165 W	165 W	350 W	350 W
Cable (2x 2,5mm ²)	10 m	10 m	10 m	10 m	10 m	10 m	10 m
Cable gland (white)	85049	85049	85049	85049	85049	850491	850491
Mounting spoiler (white)	850906	850906	850900	850906	850906	2x 850906	2x 850906
Art. No.	851061	851071	851072	851073	851074	851075	851076
Price	239,-	259,-	289,-	289,-	319,-	459,-	519,-

*Bluetooth module for MPPT solar charge controller 851005/851006

Display of relevant solar data on the smartphone via Bluetooth.

Cable length: 3 m

851007

34,90

FULL-BLACK COMPLETE SOLAR KITS- FROM 100 TO 140 WATT

- Kits include solar panel with bracket, roof feedthrough, MPPT solar charge controller and 10 m solar cable
- Monocrystalline cells, black coated aluminium frame
- With pre-installed 1 m connection cable (2x 2.5 mm²)
- Power: 100 to 140 watts
- 25 years performance guarantee
(After 25 years still 80% performance)

MPPT
Solar charge
controller in-
cluded

All kits incl. bracket,
Charge controller, roof guide
Guide incl. 10m cable

**NEW
2021**

Bluetooth module*
(optional)

**NEW
2021**

	Complete kit 100W Full-Black	Complete kit 120W Full-Black	Complete kit 140W Full-Black
Solar module power	1x 100 W	1x 120 W	1x 140 W
Solar panel	1x 85229	1x 85239	1x 85240
MPPT solar charge controller	851005	851005	851005
Controller power	165 W	165 W	165 W
Cable (2x 2,5mm ²)	10 m	10 m	10 m
Cable gland (black)	850493	850493	850493
Mounting spoiler (black)	850909	850909	850909
Art. No.	840313	840314	840315
Price	279,-	329,-	339,-

*Bluetooth module for MPPT solar charge controller 851005/851006

Display of relevant solar data on the smartphone via Bluetooth.

Cable length: 3 m

851007

34,90

POWERFUL, FOLDABLE SOLAR PANELS FOR ON THE GO

①

120 W

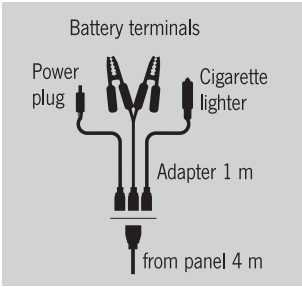
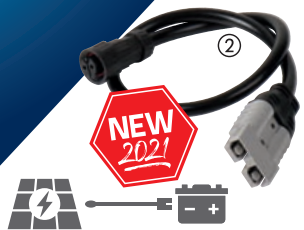

① Foldable solar panel with 120 Watt and charge controller

- 36 powerful Sunpower cells
- Built-in charge controller with additional USB output
- 4 m connection cable with 3 adapters for different connection possibilities
- Foldable to a bag

With USB charging output 5 V/1.2 A in the charge controller. Includes 3 connection adapters with crocodile clips, plug for cigarette lighter socket and 12 V power supply plug (e.g. for FOY GO). Adapter cables can be stowed in the attached pocket. Dimensions when open: 1462 x 560 x 4 mm. Folded dimensions: 440 x 560 x 20 mm. Weight: approx. 2.3 kg. 120 W panel, rated voltage 20,88 V/rated current 5,97 A

82506 329,-

② **Connection cable 50 cm** For direct connection of the Carbest Folding Panel to the Carbest Energy Station 813740 (page 14). Cable length 50 cm, 1x solar connector (only suitable for Carbest Folding Panel 82506 or Solar Case 825030), 1x 50 A high current battery connector

850921 29,90

③

120 W



③ Solar case 120 Watt

- Mobile charging of your 12 V battery
- Monocrystalline cells
- 10 A charge controller integrated
- 3 adapter cables, each 1 m long
- Charge controller incl. USB connection (for charging mobile phones & co.)
- Retractable feet
- Incl. robust hard case



Rated voltage/rated current	19.1 V/6.28 A
Efficiency	20,4%
USB port	5 V/1.2 A
Connection cable	4 + 1 m
Dimensions open in mm	1010x690x30
Dimensions closed in mm	505 x 690 x 60
Weight	12 kg
Art. No.	825030
Price	269,-

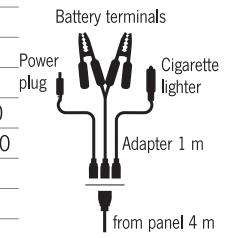

④ **Connection cable 50 cm** For direct connection of the Carbest Folding Panel to the Carbest Energy Station 813740 (page 14). Cable length 50 cm, 1x solar connector (only suitable for Carbest Folding Panel 82506 or Solar Case 825030), 1x 50 A high current battery connector

850921 29,90

⑤

50 W



⑤ Foldable solar panel with 50 W power

Easy and small to stow away and can be used anywhere. With 9 solar cells. Includes eyelets at the corners for quick attachment. Integrated bag. Weight: approx. 2.5 kg. Dimensions: 960 x 680 x 8 mm. Folded: 220 x 320 x 60 mm

82501 169,-

Connecting cable for linking up to 3 panels **82504 11,50**

SOLAR CHARGE CONTROLLER, CABLE GROMMETS AND SPOILER PROFILES



Cable bushings

For safe cable routing through roofs or walls. Small, compact, watertight. For gluing on with Sikaflex incl. PG 13.5 cable gland for cables Ø 6-12 mm.

① White, 1-fold (L12.0 x W6.5 x H3.8 cm)	85049	10,90
② Black, 1-fold (L12.0 x W6.5 x H3.8 cm)	850493	10,90
③ White, 2-fold (L12.4 x W9.3 x H3.8 cm)	850491	12,90
④ Black, 2-fold (L12.4 x W9.3 x H3.8 cm)	850494	12,90

⑤ Sturdy aluminium spoiler profile

2-part, can be shortened as required, fastened by gluing and / or screwing. Suitable for Carbest solar modules. Scope of delivery: extruded profile, plastic caps, mounting instructions

Aluminium profile bars 550 mm 2 pieces (suitable for Carbest modules 85226, 85227, 85229, 85239, 85240, 85250)

Colour white	850906	49,90
Colour black	850909	49,90

Aluminium profile rods 410 mm 2 pieces (suitable for Carbest module 85285)

Colour white	850900	44,90
--------------	--------	-------

Bluetooth-enabled MPPT charge controller, data display via app or separate monitor

- Improved version: from now on, the fuse is accessible from the outside
- Bluetooth function only in conjunction with Bluetooth module 851007 (Free app for Android and iOS)
- Battery type adjustable: GEL, lead-acid, AGM, LiFePO4 batteries
- Two battery outputs
- Max. Input voltage is 50V

⑥ charge controller 12V/12A/max. 165W	851005	69,90
⑥ Charge controller 12V/25A/max. 350W	851006	99,90
⑦ Bluetooth module with 3m cable	851007	34,90
⑧ Separate solar monitor, consisting of mounting frame and 5m cable with connector.	851003	59,90
Temperature sensor with 3m cable (without picture)	851004	6,90



⑨ Solar regulator 12V/24V, 15 A, 360W

Optical capacity display. Reliable and inexpensive charge controller for solar systems up to 360 Watt charging capacity .85135 34,90

⑩ MPPT charge controller 12V, 16A, 270W, 40V

12 V/270 W. Input voltage 40V. Battery type adjustable. For gel, AGM, acid, LiFePO4 batteries. 2 solar modules can be connected, 4-stage charging curve, integrated desulphator. Outputs for 2 batteries, with LED charge indicator lights. Dimensions: LxWxH 103x86x50 mm. 851320 79,90

⑪ SR 243 Duo Digital 12V - Effective battery charging even with little sunshine

2. Output for starter battery, charging programs for all battery types (also LiFePo4), operation display with LEDs, temperature sensor connectable, all controllers connectable to solar computer. Solar module output min./max. 30-243 Wp, Max. solar module voltage/current Solar module voltage/current: 28 V/15 A, max. charging current (Batt.1/2): 14.7 A/ 0.8 A, connection to EBL optional with 851304, dimensions (W x D x H) 131x77x40 mm, weight approx. 155 g. 85138 82,99

⑫ 50 A High Current Battery Connector Set

2-pole unisex (genderless) connector that can be used as both plug and socket. Current max. 50A, 4 receptacles for cable cross sections from 8 mm² to 16 mm² included. Dimensions: LxWxH 48x35x15,9 mm Scope of delivery: 2 x connectors (set), 4 x crimp contacts. 850920 5,95

⑬ MC4 solar connector set

Special plug set for single-core cables 2.5 - 6 mm². With snap-in locking. Set consisting of 1 x plug and 1 x socket. Protection class: unplugged IP2X, plugged IP67. Temperature range -40° to 90° C. Voltage up to max. 1000 V. Current up to max. 30 A. 84052 4,95

LITHIUM POWER FOR ON THE ROAD



Reliable & powerful
Battery technology from
60 Ah to 200 Ah.



LiFePO4 Battery 100Ah with Bluetooth Technology

- The status of the battery system can be called up at any time via smartphone
- Free app for smartphone & tablet available online
- Charging with lithium or AGM chargers possible
- Battery protection through integrated battery management
- 5 to 10 times longer service life
- 3 to 10 times faster charging
- Only approx. 1/3 of the weight of a conventional lead-acid battery
- Battery with M8 threaded connection

Type	Volt (V)	Ah*	Length mm	Width mm	Height mm	Weight kg	Art.no.	Price
100	12	100	305	170	210	13,5	81410	999,-

*Power available at 90%

Battery cannot be connected in parallel or in series!

Lithium Iron Phosphate Batteries (LiFePO4) with Battery Management

- Reliable and powerful battery technology, for tough continuous use!
- Battery protection through integrated battery management
- Up to 90% current drain (short term)
- 3 times less weight - therefore more payload possible
- 5 to 10 times longer life (approx. 2000 to 5000 cycles)
- 3 to 10 times faster charging
- Already used in series by vehicle manufacturers!
- Horizontal installation possible, e.g. VW T5/T6 and Ducato
- All batteries with M8 thread connection

Type	Volt (V)	Ah*	Length mm	Width mm	Height mm	Weight kg	Art.no.	Price
60	12	60	195	165	180	7,2	81208	549,-
100	12	100	305	170	210	13,5	81209	949,-
150	12	150	485	170	240	18	81238	1499,-
200	12	200	495	269	218	24	81239	1999,-

*Power available at 90%

Batteries cannot be connected in parallel or in series!

100 AH LITHIUM BATTERY Li100BT WITH BLUETOOTH TECHNOLOGY

Battery and charge status can be retrievable via smartphone or tablet



- State of charge can be viewed via integrated display
- Series connection possible: up to 4 batteries
- Parallel connection possible: up to 2 batteries
- Battery protection through integrated battery management
- 5 to 10 times longer service life
- 3 to 10 times faster charging
- Only approx. 1/3 of the weight of a conventional lead-acid battery
- M8 threaded connection

Reliable and powerful lithium technology for tough continuous operation. The integrated BMS (battery management system) monitors the battery internally for optimum protection. The state of charge and battery capacity are always under control via smartphone and free app. Up to 4 batteries can be connected in series or 2 batteries in parallel. A flush-mounted display in the housing shows the battery's state of charge at the touch of a button. The maximum discharge current is 100 A.

Type	Volt (V)	Ah	Length mm	Width mm	Height mm	Weight kg	Art.no.	Price
100	12	100	330	170	195	12	81413	1199,-

Available from April 2021.

Download now

The Carbest Li100BT Battery App for Smartphone & Tablet

Available from April 2021



100 Ah



Danger



M8

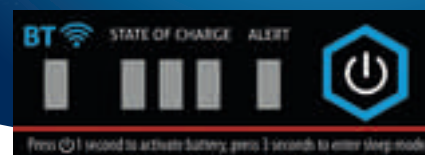

Display



Series connection & series connection possible!

DEEP-CYCLE AGM BATTERIES



- Installation in the living space possible according to EC regulations
- Absolutely maintenance-free and environmentally friendly
- Installation independent of position
- High cycle stability, also ideal for solar systems
- Shipping possible, as no dangerous goods



Danger

Carbest AGM batteries have been specially developed as service batteries for use in recreational vehicles. The ideal service battery for use in mobile travel and boats. The 100 T5 fits lying ideally under the passenger seat in Volkswagen Generation 5/6. The very good cycle stability* and the low self-discharge are perfect for the leisure sector.

Thanks to their compact dimensions, they fit into common battery fixtures and storage compartments. AGM batteries are frost-proof down to -40°C. They can be installed in any position, e.g. lying on its side or standing up. (Do not install upside down, with the battery poles facing downwards). No dangerous goods, therefore shipping possible!

Type	Volt (V)	Ah* (100 h)	Ah** (20 h)	Dimensions LxWxH (mm)	Battery pole Thread	Weight (kg)	Art.no.	Price
① 80 PL	12	90	80	350x167x179 °	M6	22,5	850529	199,-
② 100 T5	12	110	100	353x175x190	M8	26,3	850530	239,-
③ 100 PL	12	110	100	330x171x220 °	M8	29,0	850531	229,-

*C100 (value at 100-hour discharge) **C20 (value at 20-hour discharge)

° plus height of battery terminals



M6



M8

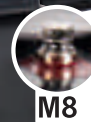

M8

ENERGY STATION

Turns a standard battery into a multifunctional power station

- Digital voltmeter for battery monitoring
- 2x USB (2,4A), 2x 12V socket, 2x 50 A high current battery connectors
- For batteries up to a size of LxWxH 320x180x220 mm

① **The energy station** is made of robust plastic and offers a wide range of connection options. Integrated in the cover are: External terminals (+/-), 1x USB double socket (2x 2.4A), 2x 12V sockets, 1x battery voltmeter, 2x high-current battery connectors for connecting solar panels and other accessories. Fuses are pre-installed. Scope of delivery includes tensioning strap to fix the lid and tensioning strap eyelets. **813740 89,90**

② **Solar adapter cable, length 50 cm** For direct connection of the Carbest Folding Panel 82506 (p. 930) or Solar Case 825030 (p. 928) to the Carbest Energy Station for charging the battery. Cable length 50 cm, 1x solar connector, 1x 50 A high current battery connector **850921 29,90**

③ **Universal adapter cable, length 3 m** For connection to Energy-Station for charging the battery or for connecting various consumers. Cable length 3m, cable cross section red/black 10mm², 1x open cable ends, 1x 50 A high current battery connector **850922 34,90**



INTELLIGENT 12V BATTERY CHARGER WITH THE LATEST 7-STAGE CHARGING TECHNOLOGY



- • For charging GEL / AGM / lead-acid batteries (recommended battery capacity: 15-100 Ah)
- • 2 charging outputs 12V
- • Automatic 7-stage charging algorithm delivers a much faster, more efficient and complete charge without voltage drops
- • This intelligent battery charger can be used as a constant current supply for accessories that require a stable and clean DC voltage
- • LCD control panel / monitor integrated

Product	Dimensions mm	Weight approx.	Recommended Battery capacity	Art.no.	Price
10 A	176x175x95	1,3 kg	50-100 Ah	80283	119,-
15 A	176x175x95	1,3 kg	50-150 Ah	80284	179,-
20 A	176x175x95	1,3 kg	100-200 Ah	80285	199,-



PROFESSIONAL CHARGERS WITH 10 A OR 20 A

3-step charging, battery type selectable, suitable for gel, AGM, lead acid & lithium batteries. Input voltage: 180-240 V AC, output voltage: Max. 14.6 V DC. Incl. connection cable and battery clamps.

Charger 10 A, weight approx. 1,4kg, dimensions: 130 x 150 x 50 mm **80280 79,90**

Charger 20 A, weight approx. 2,0kg, dimensions: 160 x 150 x 70 mm **80281 99,90**



THE INTELLIGENT CHARGER WITH 4 A

- LCD display
- Diagnostic & revive function
- For all 6/12V batteries (AGM, Gel, Wet)
- 5 step charging program
- Controlled trickle charge

Microprocessor controlled charger with 4.0 A charging power. Technical data: Protection class IP65, battery capacity: max. 120 Ah. Input voltage: 220-240 V AC/50 Hz, max. 70 W. Output voltage: max. 14.7 V DC/4.0 A. Dimensions: (LxWxH) 18 x 8 x 5 cm. Weight: 0.5 kg **819010 35,99**

OPERATE 230 VOLT DEVICES ON 12 VOLT WITH SINUSOIDAL VOLTAGE

- Use of many common household appliances
- USB connection 5 V ~ 2.1 A
- Battery protection through undervoltage and overvoltage shutdown
- Reverse polarity protection
- Integrated overload protection
- Overtemperature shutdown (> 75°C)





Figure	① Power Inverter 200 W	② Power Inverter 400 W	③ Power Inverter 600 W	④ Power Inverter 1000 W
Input voltage DC	12 V	12 V	12 V	12 V
Input voltage range	10.5 V-16V	10.5 V-16V	10.5 V-16V	10.5 V-16V
Rated power / peak power short-time(2S)	200 W / 400 W	400 W / 800 W	600 W / 1200 W	1000 W / 2000 W
Output voltage (±5%)	220 - 240 V	220 - 240 V	220 - 240 V	220 - 240 V
Switch-off threshold/undervoltage	10.0±0.5 V	10.0±0.5 V	10.0±0.5 V	10.0±0.5 V
Quiescent current	<0,17 A	<0,21 A	<0,3 A	<0,33 A
Efficiency	>90%	>90%	>90%	>90%
Cooling	Fan	Fan	Fan	Fan
Fuse	yes	yes	yes	yes
Connection for remote control	no	no	no	no
USB 5 V ~ 2.1 A	yes	yes	yes	yes
Socket	1	1	1	1
Dimensions (W x H x D) in mm	120 x 100 x 50	120 x 100 x 50	150 x 100 x 50	210 x 150 x 70
Weight	approx. 0.6 kg	approx. 0.7 kg	approx. 1 kg	approx. 2 kg
Art. No.	82291	82292	82293	82294
Price	39,99	44,90	74,90	119,-

Approved for installation in vehicles (E-mark and CE certified).

INVERTER WITH PURE SINE WAVE VOLTAGE FOR SENSITIVE 230V DEVICES



 Sinus
 12V
 230V
 INCL. CONNECTION-CABLE
 C6

Connection cable included in delivery included (2x 2m + 1x 0,4m)

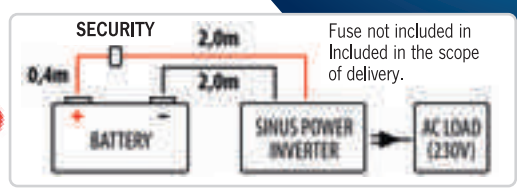

Suitable cable remote controls

For ① with 4,5 m cable
81949 24,90

For ② ③ ④ ⑤ with 5 m cable
81947 24,90



- Extremely high starting current, up to 3 times the power output
- Convert 12 volt battery current to 230 volt
- No restriction in operation, suitable for measuring computer or microwave oven
- Switch-mode technology: Almost noiseless - Lightweight & compact
- Battery protection by undervoltage shutdown
- Overtemperature shutdown (approx. 60° C)
- Reverse polarity protection
- Integrated overload protection

Automatic load detection - The inverter switches to an energy-saving mode if no power is drawn for one minute. Fan - When the temperature is too high, the built-in temperature controlled fan will automatically turn on for cooling. Aluminium housing - Suitable for floor & wall mounting.

NOTE: Required fuse
 For the installation of the inverters on this page we recommend a 12V fuse.
 300W=50A / 700W+1000W=100A / 1500W=150A / 2000W=200A / 3000W=300A.

Figure	①	②	③	④	⑤	⑥
Type	PS300U	PS700U	PS1000U	PS1500U	PS2000U	PS3000U
Input voltage DC	12 V	12 V	12 V	12 V	12 V	12 V
Output voltage (±5%)	230 V	230 V	230 V	230 V	230 V	230 V
Continuous output	300 W	700 W	1.000 W	1.500 W	2.000 W	3.000 W
Nominal power	300 W	700 W	1.000 W	1.500 W	2.000 W	3.000 W
Peak power shortz.	600 W	2.100 W	3.000 W	4.500 W	6.000 W	9.000 W
Shutdown threshold/undervoltage.	10.0±0.5 V	10.0±0.5 V	10.0±0.5 V	10.0±0.5 V	10.0±0.5 V	10.0±0.5 V
Quiescent current	≤0,6 A	≤0,3 A	≤0,4 A	≤0,5 A	≤0,6 A	≤0,8 A
Efficiency	≥90%	≥90%	≥90%	≥90%	≥90%	≥90%
Remote control connection	yes	yes	yes	yes	yes	yes
USB port/ampere	yes/2.1A	yes/2.1 A	yes/2.1 A	yes/2.1 A	yes/2.1 A	yes/2.1 A
Sockets	1	1	1	2 (1x Schuko, 1x Universal)*		
3 connection cables included	2x 2m & 1x 0,4m (4mm²)	2x 2m & 1x 0,4m (16mm²)	2x 2m & 1x 0,4m (25mm²)	2x 2m & 1x 0,4m (50mm²)	2x 2m & 1x 0,4m (50mm²)	2x 2m & 1x 0,4m (50mm²)
Dimension (LxWxH) mm	260x150x60	255x186x90	317x186x90	320x152x105	320x152x105	475x250x110
Weight	1.6 kg	2,4 kg	3.0 kg	4,7 kg	4.8 kg	6.5 kg
Art. No.	82281	82285	82282	82286	82283	82284
Price	119,-	209,-	349,-	529,-	649,-	839,-

Approved for installation in vehicles (E-mark and CE certified). *Not designed for simultaneous operation!

SINE WAVE INVERTER WITH INTEGRATED MAINS PRIORITY CIRCUIT

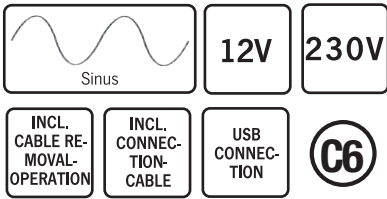

Incl. connection cable & cable remote control

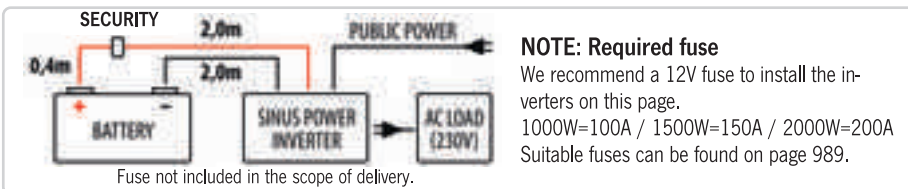

See Video



Figure	①	②	③
Type	Sine Power Inverter 1000 W	Sine Power Inverter 1500 W	Sine Power Inverter 2000 W
Input voltage DC	12 V	12 V	12 V
Output voltage (±5%)	230 V	230 V	230 V
Continuous output	1000 W	1500 W	2000 W
Nominal power	1000 W	1500 W	2000 W
Peak power shortz.	2000 W	3000 W	4000 W
Shutdown threshold/undervoltage.	10.5±0.5 V	DC 10.5±0.5 V	DC 10.5±0.5 V
Quiescent current	≤0,45 A	≤0,75 A	≤0,75 A
Efficiency	>90%	>90%	>90%
Switchover time 230 V to 12 V (approx.)	≤ 8 ms	≤ 10 ms	≤ 10 ms
Sockets	1x Schuko, 1x Universal*	1x Schuko, 1x Universal*	1x Schuko, 1x Universal*
3 connection cables included	2x 2m & 1x 0,4m (25mm ²)	2x 2m & 1x 0,4m (50mm ²)	2x 2m & 1x 0,4m (50mm ²)
Battery charger (Gel/AGM)	10 A	15 A	15 A
Dimension LxWxH in mm (approx.)	330 x 230 x 110 mm	400 x 230 x 110 mm	400 x 230 x 110 mm
Weight	approx. 3,6 kg	approx. 5,3 kg	approx. 5,7 kg
Art. No.	82277	82278	82279
Price	389,-	569,-	675,-

- **Integrated 230 volt mains priority circuit:**
As soon as 230 volt shore power (e.g. from a campsite) is available, the inverter operation is automatically interrupted. The inverter operation is immediately resumed as soon as no more external power is available.
- **Conversion of 12 V to 230 V sinusoidal voltage**
- **Very high starting current possible**
- **3-stage battery charger for gel & AGM batteries**
- **Battery protection through undervoltage cut-off**
- **Reverse polarity protection**
- **Integrated overload protection**
- **Temperature controlled fan**
- **Aluminium housing, lightweight yet sturdy**
- **With USB connection**
- **Including connection cable and cable remote control**

Spare/extension cable

Pre-assembled with 2 ring lugs.

± 25 mm ² , 2 x 200 cm	81940	46,90
± 50 mm ² , 2 x 200 cm	81941	76,90

Cable remote control (as spare part)

81946	24,90
-------	-------

Approved for installation in vehicles (E-mark and CE certified). *Not designed for simultaneous operation!

WIDESCREEN LED TVS WITH TRIPLE TUNER DVB-T2/-S2/-C



- Wide Angle Displays
- 16:9 widescreen format
- Incl. indoor DVB-T rod antenna
- Extra on/off switch on the unit

12~30 VOLT	100~240 VOLT	DVB-T2 DVB-S2 DVB-C	H.265 DVB-T2
HDMI	USB 2.0	CI+ SLOT	MPEG4
DVD PLAYER	SCART VGA	VIDEO TEXT	HEVC 10 bit



* until 28.2.2021 / ** as of 1.3.2021
 ** as of 1.3.2021, the new EU energy label will be introduced in accordance with Regulation (EU) 2019/2016, which is based on a new test procedure with a new calculation formula.



Device type	18.5" HD READY	21.5" FULL HD	23.6" FULL HD
Screen format	16:9 widescreen format		
Viewing angle	170° H / 160° V	170° H / 160° V	176° H / 176° V
Operating voltage	12V DC / 24V DC / 230V AC		
TV connections IN	2x RF, 1x Scart, 1x HDMI, 1x VGA, 1x PC Audio, 1x AV, 1x Ypbpr, 1x CI+ Slot, 1x USB 2.0		
TV connections OUT	1x coaxial, 1x headphone		
Power consumption operation / standby	36W / <0.5W	36W / <0.5W	36W / <0.5W
Resolution (Pixel)	1366 x 768	1920 x 1080	1920 x 1080
Contrast	1000:1	4000:1	3000:1
Brightness (cd/m2)	200	200	220
Dimensions (mm): Without foot / With foot	WxHxD 435x310x45/180	WxHxD 500x345x45/180	WxHxD 545x375x45/180
EU energy efficiency class until 03/2021	A		
Weight	2,6 kg	2,9 kg	3,4 kg
Scope of delivery	LED-TV, power supply 100-240V, car adapter 12-30V with cigarette lighter plug, mobile indoor DVB-T rod antenna, mini AV cable, mini ypbpr cable, remote control, manual		
Item no. / Price	49880 279,-	49882 319,-	49884 359,-

We reserve the right to make technical improvements or changes, as well as to supply a qualitatively comparable product from another manufacturer or supplier or supplier. The illustrations are similar to the delivered products. Dimensions without guarantee.

SMART TV - SAT-TV & INTERNET

- For a great multimedia experience
- WiFi, DVB-S2 (SAT), DVB-C (Cable), DVB-T2 with HD (Terrestrial)
- Large viewing angle
- Extra slim case
- Android System

12~30 VOLT	100~240 VOLT	DVB-T2 DVB-S2 DVB-C	H.265 DVB-T2
HDMI	USB 2.0	CI+ SLOT	MPEG4
WLAN	SCART VGA	VIDEO TEXT	HEVC 10 bit



Device type	23.6" FULL HD	27.5" FULL HD	32" FULL HD
Screen format	16:9 widescreen format		
Viewing angle	170° H / 160° V		
Operating voltage	12V DC / 24V DC / 230V AC		
TV connections IN	1x HDMI, 2x USB 2.0, 1x VGA, 1x PC audio, 1x CI+ slot, 1x AV, 1x RJ45		
TV connections OUT	1x coaxial, 1x headphone		
Power consumption operation / standby	36 W / <0,5 W	36 W / <0,5 W	36 W / <0,5 W
Resolution (Pixel)	1920 x 1080	1366 x 768	1920 x 1080
Contrast	3000:1	3000:1	3000:1
Brightness (cd/m2)	200	220	220
Dimensions (mm): Without base, WxHxD	551 x 43 x 327	638 x 45 x 379	731 x 94 x 431
Dimensions (mm): With foot, WxHxD	551 x 171 x 338	638 x 187 x 415	731 x 182 x 483
EU energy efficiency class from 03/2021	F	E	F
Weight	3,3 kg	4,0 kg	5.0 kg
Scope of delivery	LED-TV, stand, power supply 100-240V, car adapter 12-30V with cigarette lighter plug, remote control, manual		
Item no. / Price	49892 399,-	49891 479,-	49890 569,-

We reserve the right to make technical improvements or changes, as well as to supply a qualitatively comparable product from another manufacturer or supplier. The illustrations are similar to the delivered products. Dimensions without guarantee.

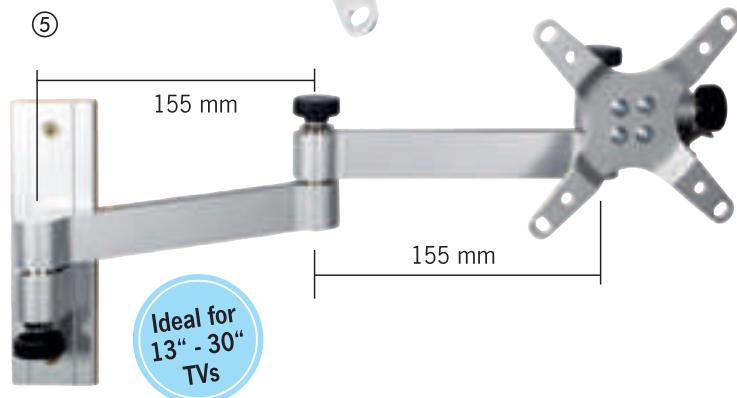
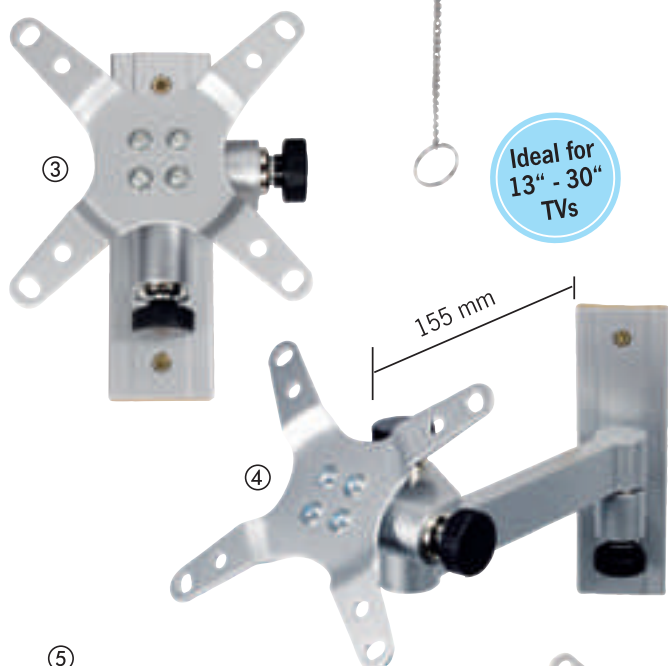
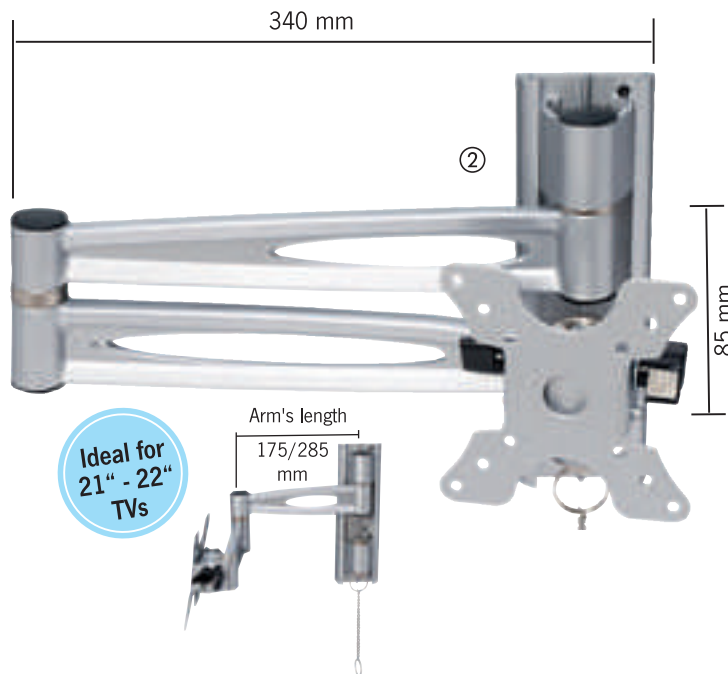
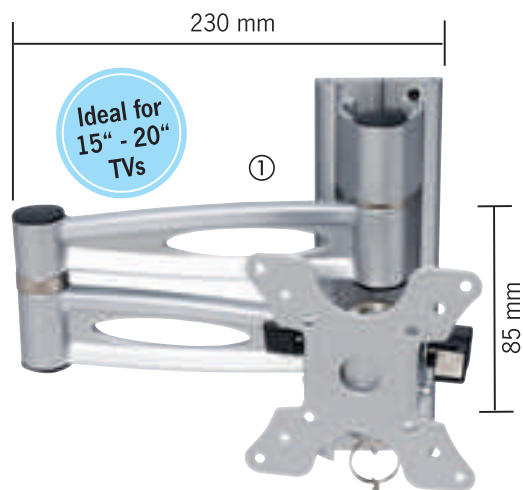

STRONG TV WALL BRACKET FOR CARBEST TV

TV wall bracket with locking bolt

- Wall Mount TFT holder in 2 versions
- For screens from 15" to 23".
- Hole ring 50, 75 and 100 mm (VESA)

- ① **Carbest TV Holder Simon Luxury**
Secure locking while driving. Arm length 175 mm each. Length folded out 430 mm. Load capacity up to 10 kg. Weight approx. 1 kg. Aluminium silver. **493960 69,99**
- ② **Carbest TV mount Simon Luxus XL**
LikeTV-holder Simon Luxus, but arm length 285 mm each. Length folded out 650 mm. Load capacity up to 10 kg. Weight approx. 1,4 kg. Aluminium silver. **493970 79,99**

TV wall bracket with clamping screws

- Wall Mount TV holder in 3 versions
- For screens from 13" to 30".
- Perforated rim 75 and 100 mm (VESA)

- ③ **Wall Mount TV Holder S**
The quality has been improved with new knurled screws. Dimensions: 114 x 114 x 98 mm. Load capacity up to 10 kg. Weight 0,6 kg. Aluminium silver. **493962 29,99**
- ④ **Wall Mount TV Holder M**
Dimensions: 116 x 152 x 81 - 235 mm Load capacity up to 10 kg. Weight 0,8 kg. Aluminium silver. **493961 47,99**
- ⑤ **Wall Mount TV holder XL, aluminium**
Dimensions: 116 x 152 x 81 - 390 mm Load capacity up to 10 kg. Weight 1 kg. Aluminium silver. **49396 49,90**

COMPACT DVB-T2 ANTENNAS FOR OUTDOORS, CAR OR CAMPER

Eric - Digital DVB-T2 Antenna

DVB-T2 $\frac{12V}{24V}$ 230V

- For the reception of digital terrestrial signals
- With high-quality amplification and circuit technology
- Protected against UV rays and splash water
- Suction cup included for installation on smooth surfaces
- 12/24-volt operation with cigarette lighter connection
- 230-volt power adapter included
- For TVs with 5 V supply via antenna output
- For TV sets without 5 V supply, the 5 V supply voltage can be looped in via 12 V & 230 V

Technical data: DC 12/24 volt, UHF 470~870 MHz, VHF 47~230 MHz, Gain level: 20 +- 3dB low loss amplification technology. Dimensions: H 200 x W 105 x D 80 mm (without base). **Scope of delivery:** Antenna, flexible mounting bracket, mast mounting set, 5 V component for supply voltage, coaxial cable, 12 V and 230 V power adapter, flexible mounting part with suction cup Ø 70 mm, cigarette lighter cable, operating instructions

494101 49,90



Fixed installation or mobile mounting possible

Proven for 4 years in use

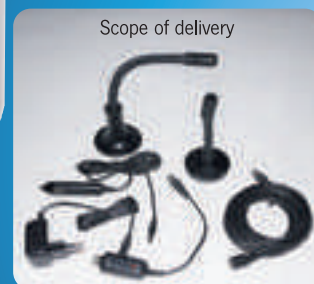

Scope of delivery

The active DVB-T2 omnidirectional antenna for roof mounting with TOP reception

DVB-T2 $\frac{12V}{24V}$

- Reception of regional digital programmes
- Integrated amplifier
- Concealed cable routing (through antenna base)

Antenna with the latest SMD technology. Excellent reception of digital terrestrial TV (DVB-T) and radio programs (DAB Radio). Reception of local/regional FM radio signals. With built-in amplifier. Extremely wide frequency range. Weatherproof, rustproof, design with aluminium base.

Technical data:

Frequency ranges: FM 87.5-108 MHz, VHF 174-230 MHz, UHF 470-862 MHz. Aperture angle: vertical 90°/horizontal 360°. Output level: max. 108 dB, gain: 35 dB, input voltage: DC 12/24 V, operating voltage: 5 V DC, connection: F-plug. Dimensions: Ø base: 13 cm, Ø antenna: 30 cm, total height: 20 cm

49410 109,90



Expert Tip

Cable routing through aluminium base

TRAVELSAT

68 II AND 80 II

PREMIUM SATELLITE SYSTEMS
WITH BLUETOOTH CONTROL
CONVENIENT VIA SMARTPHONE



Complete satellite system control possible via the app or via optional control panel

Plant software updates yourself via the app. No more service workshop appointments necessary!



Proven Travelsat quality now with Bluetooth technology!

- All antennas with Bluetooth technology
- Convenient operation via smartphone - software updates can be easily carried out via app annoying workshop appointments are eliminated
- Powerful LNBS for excellent
- TV reception even in peripheral areas
- Powerful rotating mechanism and robust Metal and aluminium components for a long life
- Service life and quiet operation

Technology: The Travelsat II series with the latest hardware and software technologies. Easy to update and future-proof: HD and DVB-T2

Control unit: The system is compatible with all decoders (also Sky HD). Reprogrammable software connection without opening the box

Positioning: Fast search of the satellite position Thanks to GPS, the search time is approx. 30-60 sec, 5-10 seconds when changing satellites. Automatic satellite alignment at the push of a button. 1, 7 or 15 pre-stored satellites. Storage of the last recorded position. Acoustic signal warns when vehicle is started, if antenna is open (Plus)

Details: Aluminium mounting plate for secure and easy attachment to the Vehicle High precision steel & bronze gears long life with minimal maintenance.

Technical data: 12 volts/27 watts (Max 48 watts when retracting and extending), -15°C to +50°C. With CI slot (Common Interface), OSD.

Scope of delivery Outdoor antenna, control unit without receiver, cable, roof bushing, mounting material, mounting plate and instructions.

Travelsat II Ø 68 cm with Bluetooth Control. Software updates can now be carried out conveniently via the app.

Travelsat II Ø 68 cm, ASTRA single system (for 1 receiver)
All other satellites can be selected via app or control panel.

NEW! Colour anthracite 496380 1399,-
Colour white 49638 1399,-

Travelsat II Ø 68 cm, ASTRA Twin system (for 2 receivers)
All other satellites selectable via App or control panel.

Colour white 49639 1519,-



Travelsat II 80 with Bluetooth

ASTRA system with Bluetooth. All other satellites
Satellites can be selected via app or control panel

Single system (for 1 receiver) with Bluetooth
49640 1569,-

Single system (for 1 receiver) with Bluetooth + Skew
49641 1999,-

Twin system (for 2 receivers) with Bluetooth
49642 1699,-

Twin system (for 2 receivers) with Bluetooth + Skew
49643 2199,-

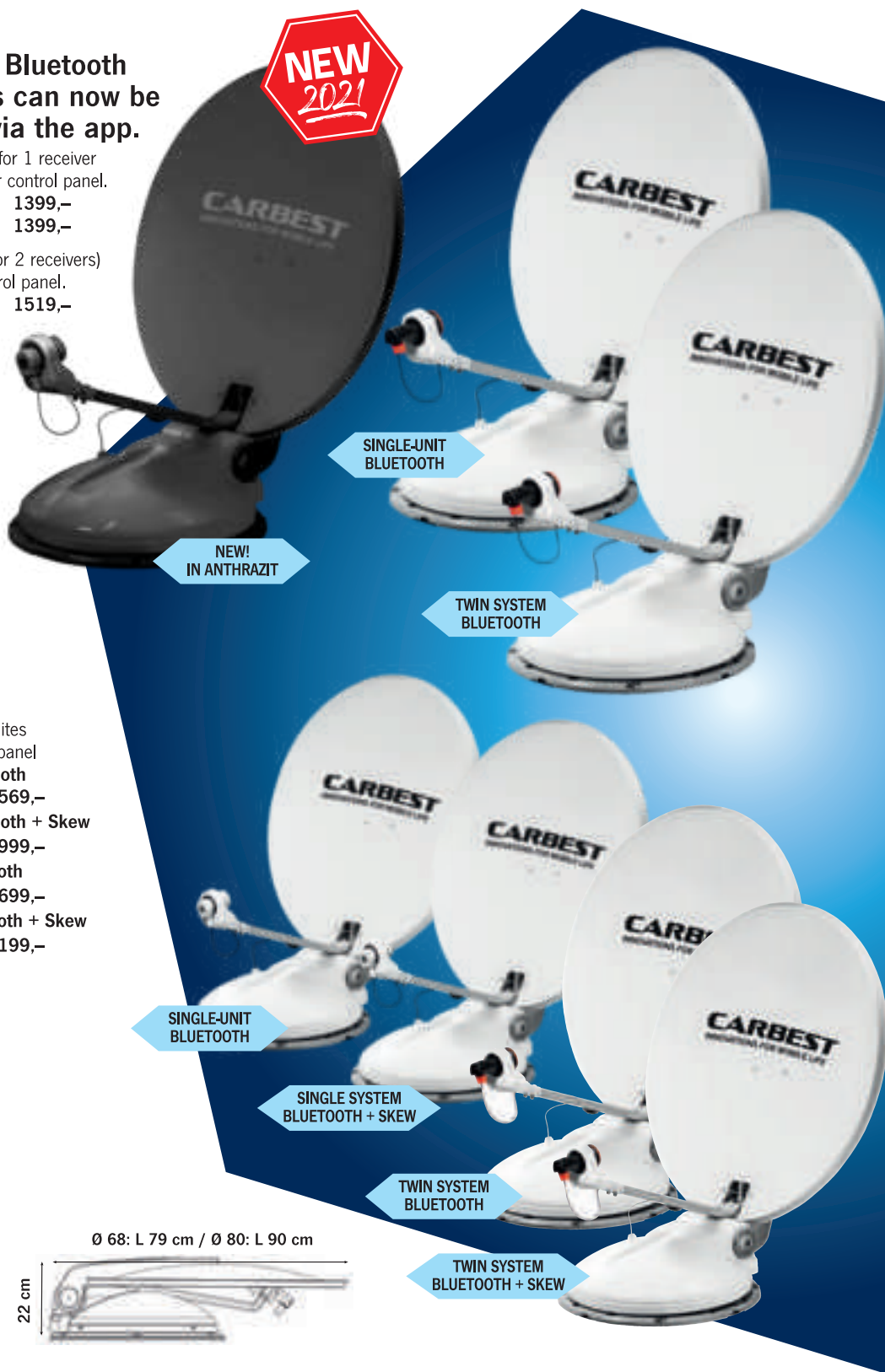

TWIN system: The Twin system has a second SAT connection for a further digital or HD receiver, e.g. for a TV in the sleeping area. This allows independent programme selection at both Connections (receiver not included).

Service: The comprehensive SR-Mecatronic service network ensures quick repair or replacement in case of service. So the Travelsat is quickly ready for use again

Optional control panels: As an alternative to the Bluetooth control, 2 control panels are available: The LED control panel with 7 pre-programmed satellites and the Comfort "Plus" LCD control panel with 15 pre-programmed satellites.



LED control panel 7 pre-programmed satellites:
Hotbird 13E, Astra 19, Thor, Sirius, Atlantic Bird, Hispasat, Astra 28.
49724 149,-



Comfort "Plus" LCD control panel. 15 pre-programmed satellites and additional functions:
Hotbird 13E, Astra 19E, Astra 28E, Eurobird 16E, Thor 1W, Sirius 5E, Atlantic Bird 5W, Hispasat30W, Eurobird 9E, Eutelsat 7E, Eutelsat10E, Amos 3W, Atlantic Bird 8W, Atlantic Bird 12W, Astra 23.5E
49725 179,-

MULTISAT

X65 / X85 SINGLE AND X85 TWIN + SKEW

QUALITY AT A TOP PRICE!

- Automatic folding when engine starts
- Extremely robust, maintenance-free metal drive
- Super-easy operation, receive at the push of a button
- The desired satellite at the push of a button

Technical data: 10 satellites pre-prommed, input frequency: 10.7 ~ 12.75 GHz, output frequency: 950 ~ 2,150 MHz, polarization: vertical and horizontal, angular range elevation: 0° ~ 145°, angular range azimuth: 390°, power supply: DC 12 Volt, operating temperature: -20° C to +60° C. Scope of delivery: Multi-Sat antenna, controller, roof duct, mounting plate LNB protective film, connection cable, screws, operating instructions.

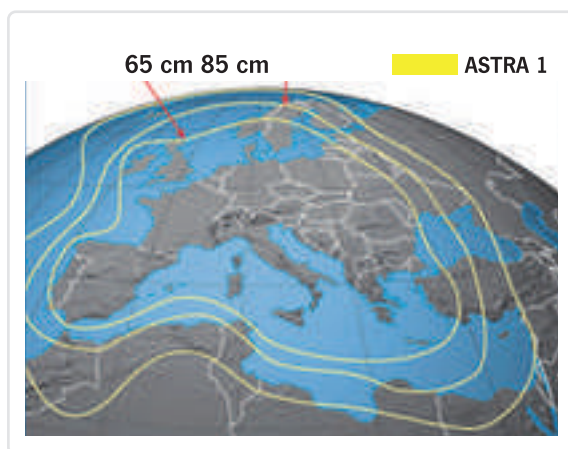

Satellite Antenna Multi-Sat X65 Single 10 satellites preprogrammed

SAT system Multisat 65 cm Single LNB, preinstalled satellites: **Turksat, Astra 2, Astra 3, Astra 1, Hotbird, Eutelsat 9, Astra 4, Thor, Eutelsat 5W, Hispasat**, compact and yet great reception power, satellite search time max. 180 seconds, software update via USB ,dimensions retracted: 88.5 x 66 x 18.4 cm, weight: approx. 12 kg
49631 999,-

12 V Ø 65 cm SINGLE LNB 10x SAT DiSEqC 1.0/1.1



Satellite Antenna Multi-Sat X85 Single 10 satellites preprogrammed

SAT system Multisat 85 cm Single LNB, pre-installed satellites: **Turksat, Astra 2, Astra 3, Astra 1, Hotbird, Eutelsat 9, Astra 4, Thor, Eutelsat 5W, Hispasat**, compact and yet great reception power, satellite search time max. 180 seconds, software update via USB ,dimensions retracted: 110.5 x 86 x 18.4 cm, weight: approx. 14 kg
49632 1199,-

12 V Ø 85 cm SINGLE LNB 10x SAT DiSEqC 1.0/1.1



Satellite Multi-Sat X85 Twin + Skew 10 satellites preprogrammed

SAT system Multisat 85 cm Twin LNB + AUTO SKEW, pre-installed satellites: **Turksat, Astra 2, Astra 3, Astra 1, Hotbird, Eutelsat 9, Astra 4, Thor, Eutelsat 5W, Hispasat**, compact and yet great reception power, satellite search time max. 180 seconds, software update via USB ,dimensions retracted: 110.5 x 86 x 18.4 cm, weight: approx. 14 kg
49633 1499,-

12 V Ø 85 cm TWIN LNB AUTO SKEW GPS 10x SAT DiSEqC 1.0/1.1



SNIPE PRO AND PRO MAX

SNIPE PRO HIGHLIGHTS

- Active GPS receiver for short search times
- Automatic SKEW function
- Extremely flat, robust aluminum housing (only 22.2 cm high)
- 10 satellites pre-programmed, selectable at the external control unit
- Extra amplification for high wind loads

SNIPE PRO MAX HIGHLIGHTS:

Identical to SNIPE PRO, but with extremely high reception power (47 dBW) and range

Comfort functions of the Snipe PRO and Snipe PRO MAX:

Auto-Skew function, automatically compensates for polarization shifts by rotating the receiving antenna. This ensures the best possible reception at all European locations. In addition, an active GPS receiver is integrated, which is kept in stand-by via built-in backup batteries without vehicle power. Search time to the satellite only 1 - 2 minutes. Wide angle for reception in Southern and Northern Europe (5 - 90°). Automatic retraction when vehicle is started. Auto-update of transponder data via satellite keeps the Snipe always up to date. With DVB-S2 also suitable for HD television. Technical changes reserved

Technical data for SNIPE PRO and SNIPE PRO MAX:

1-participant universal LNB. Frequency range: 10.7 - 12.75 GHz, frequency band: Ku Band, polarization: linear (horizontal/vertical), received power: 50 dBW, antenna gain: 33,7 dBi (Snipe Pro) u. 36,1 dBi (Snipe Pro Max), angular ranges: Azimuth: 360°, Elevation: 5° - 90°, Skew: -60°/+60°. Temperature range: -20 to +60°C. Voltage range 12 to 24 volts. Power consumption: max. 75 W (search process)

10 satellites pre-programmed:

Astra 1, Astra 2, Astra 3, Astra 4, Hotbird, Thor, Eutelsat 5 West A, Türksat, Hispasat, Eutelsat 9A.

Scope of delivery:

Antenna, control unit, bracket for control unit, 12 V connection cable, 12 m coaxial cable for receiver and control unit, roof feed-through, mounting plate and operating instructions.

Snipe PRO: Space requirement with maximum turning range of the antenna: approx. 640 mm. (LxWxH): 49,1 x 51,1 x 22,2 cm, Antenna closed: H: 22,2 cm, weight: 13,5 kg

48295 1299,-

Snipe PRO MAX: Space requirement with maximum turning range of the antenna: approx. 640 mm. (LxWxH): 51.1 x 63.8 x 24.6 cm, antenna closed: H: 24.6 cm. Weight: 16,5 kg

48296 1599,-

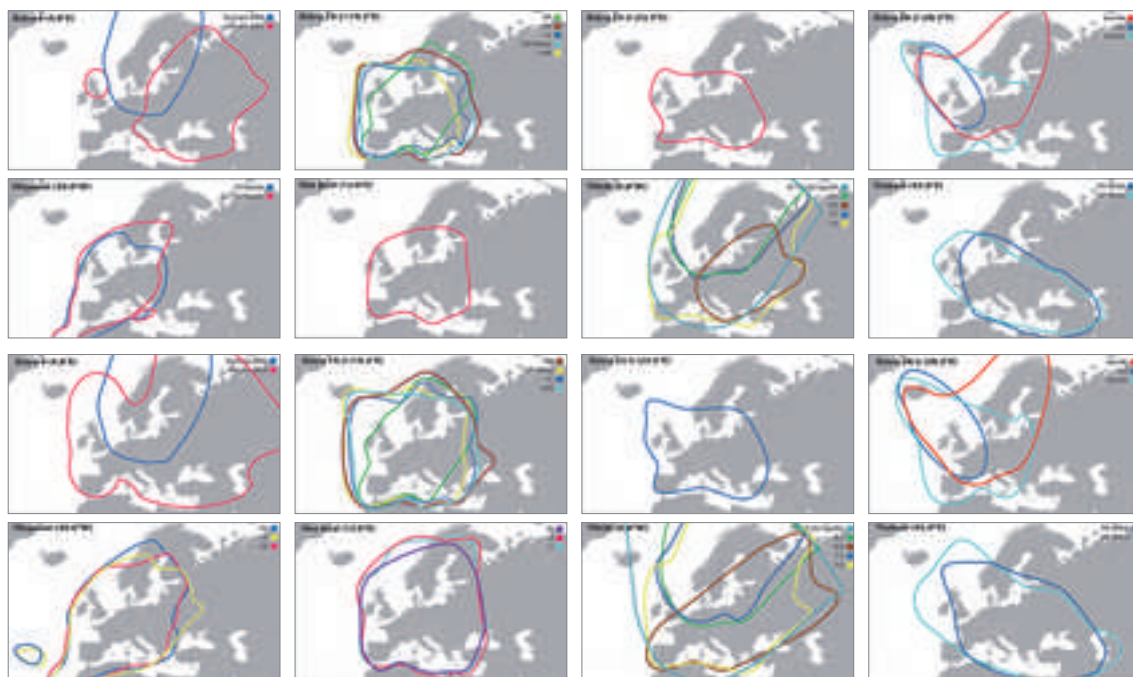
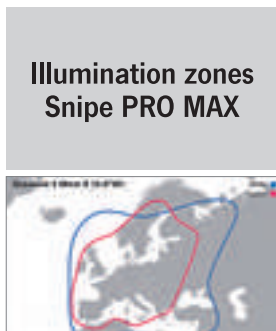
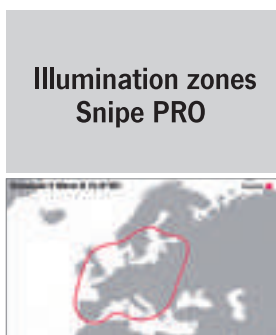

SNIPE III

OPTIMUM ILLUMINATION ZONE THROUGH AUTO-SKEW AND 10 PRE-PROGRAMMED SATELLITE

Integrated GPS receiver

DiSEqC 1.0 / 1.1

With reinforced housing front

- Multi-reception, 10 satellites pre-programmed
- Optimum footprint due to auto-skew
- Permanent installation on motorhome/caravan incl. mounting kit
- Compact dimensions, therefore suitable for many vehicles
- Satellite search time max. 120 seconds
- Extremely robust housing reliably protects the rotating mechanism

Specifications:

Input frequency: 10.7~12.75 GHz, Output frequency: 950~2,150 MHz. Signal gain: 33.7 dBi/12.7 GHz, Polarization: vertical/horizontal, Angle range 15°~90°.Azimuth: 360°, Operating temperature: -30°C~+60°C, Voltage 12 Volt. Power consumption: 30 watts during satellite search. Software update via USB on the control panel
 10 satellites pre-programmed: (ASTRA 1/2/3/4, HotBird, Türksat, Thor, AB3, Eutelsat, Hispasat)
 Dimensions: approx. 515 x 355 x 210 mm. Weight: approx. 10.3 kg.

Scope of delivery: Motor unit with control electronics, mounting plate, roof duct, transport case and cable set. Flat antenna pre-mounted on outdoor unit. With control unit, 12 V connection cable and operating instructions. Colour white.

482943

999,-

SKEW Function



HD

Illumination zones (Eutelsat 9A without fig.):

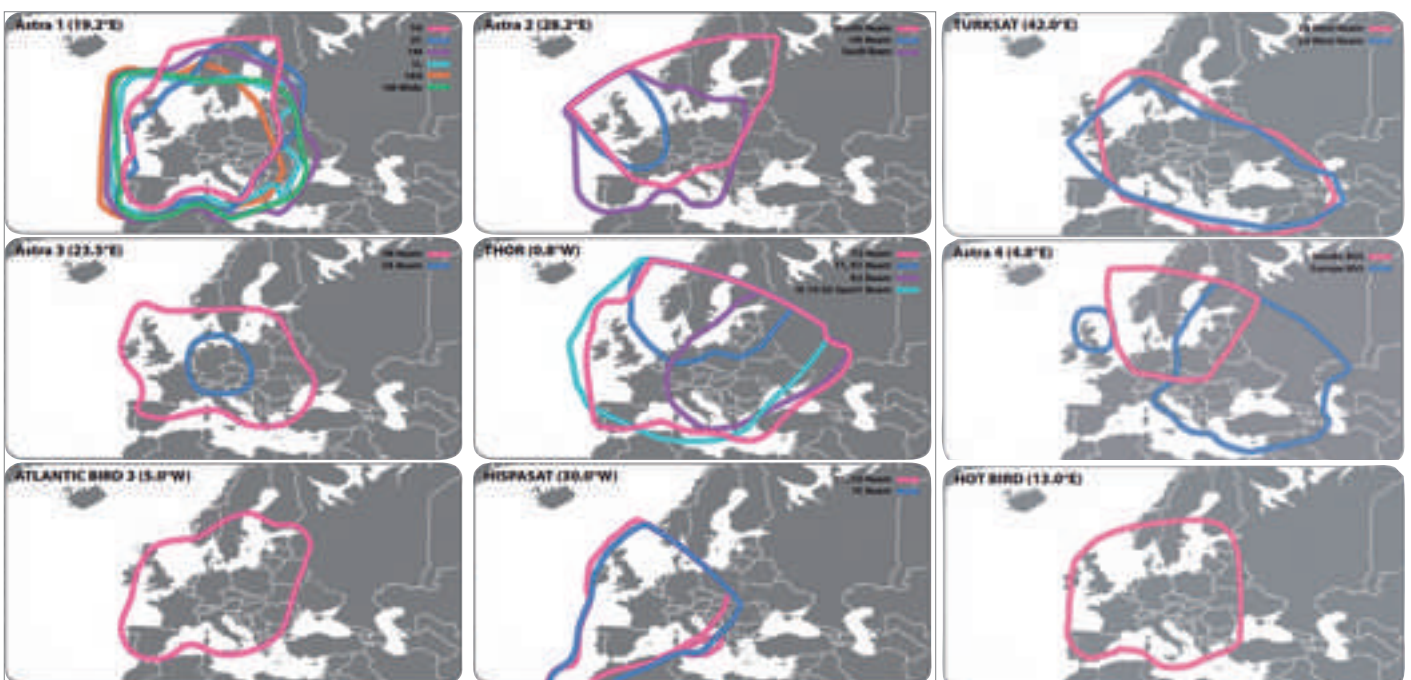

TV streaming
to mobile devices



Different programs can be viewed
on up to 8 mobile devices.



SNIPEDOME

AERODYNAMIC DOME ANTENNAS

Snipe Dome WiFi TV for LIVE TV

- Identical to Snipe Dome, but with TV transmission to mobile devices such as smartphone or PC tablet

With the Snipe Dome WiFi TV, TV signals can be transmitted directly to smartphones, tablets and notebooks via built-in wifi. Different programmes can be watched on a maximum of 8 mobile devices. (Max. distance 80 m in free field). Please note: Interference-free transmission of SAT>IP signals to mobile devices is only guaranteed with the 5 GHz band. Please check whether your mobile devices support the 5 GHz band.

Snipe Dome

- 8 satellites preprogrammed
- GPS receiver for faster satellite search
- Automatic SAT search at the push of a button
- Compact and aerodynamic

Aerodynamic and compact design. The positioner works independently and can be operated with any satellite receiver. The GPS receiver shortens the satellite search time to only 1-2 minutes.

Model name	Snipe dome	Snipe Dome WiFi TV
Number of LNBs	1	1
Signal amplification	33.7 dBi	33.7 dBi
Receive power	50 dBW	50 dBW
GPS/Skew	x/-	x/-
Power supply	12/24 V	12/24 V
WLAN	-	x (8 participants)
Temperature range	-30 °C - +60 °C	-30 °C - +60 °C
Search angle	15° - 75°/390°	15° - 75°/390°
Pre-program. Satelliten	8	8
Dimension Ø x H approx	660 x 315 mm	660 x 315 mm
Weight approx.	10 kg	10 kg
Part number	48298	48299
Price	999,-	1699,-



SNIPE HANDY PORTABLE SAT SYSTEM

- Small, lightweight, portable, no fixed installation necessary
- Perfect for mobile use: the antenna can be placed anywhere with a clear view to the satellite
- Single LNB, 4 satellites pre-programmed (Astra1, Astra2, Hotbird, Eutelsat 5W)
- Integrated theft protection (optical and acoustic)

The robust plastic hood provides the best possible protection against the weather influences. The carrying handle facilitates transport. 1-cable connection: connection of the antenna with the controller incl. power transmission via coaxial cable. Incl. radio remote control. Satellite search time: approx. 180 sec., power consumption: 30W. Signal amplification: 31 dBi, reception power: 51 dBW, search angle

15° - 90°/360°, metal eyelet for fixing a steel cable against theft. In addition, acoustic warning signal if coaxial cable is not removed, Approx. dimensions: Ø 450mm, H 390 mm. (Delivery without steel cable)



49796

779,-

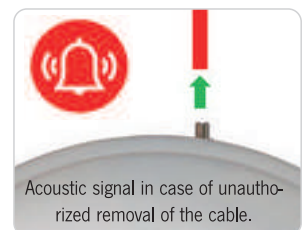
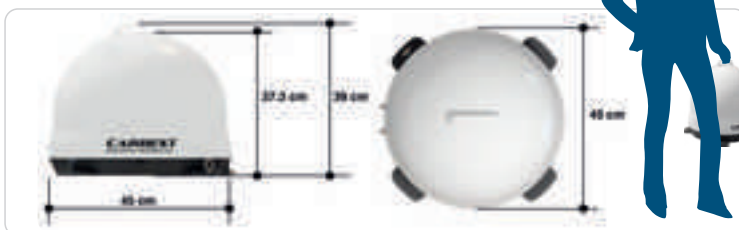

Connection diagram:

1-cable solution: With only 1 cable the Snipe Handy is connected to the controller. This transmits the satellite signal and simultaneously supplies the antenna with power.

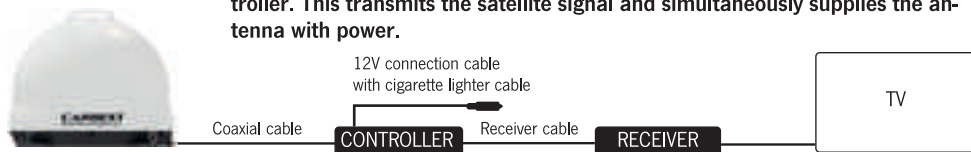



HIGH-QUALITY
**VEHICLE-
ELECTRONICS
FOR CAMPING
& LEISURE.**

12 V WIRELESS REAR VIEW CAMERA SYSTEMS - CAMERA AND MONITOR IN A SET

- Insensitive to interference, range: approx. 32 m
- 2-channel video, split view, audio
- Dust and water protected
- Vibration resistant
- E8 certified

Specifications 7" LCD Monitor

2.4 GHz, resolution: 800 x 480, contrast: 500:1, viewing angle: V:110°, H140°, input voltage: 10-16 V, video system: PAL and NTSC, picture: 4:3/16:9, brightness: 450 cd/m², adjustable universal mount, operating temperature: -30°+70°, operating voltage: 10-36 V

Technical data camera: colour sensor, waterproof according to IP69K, video system: NTSC 720x480, PAL 756x504, resolution: 600 TV lines, minimum light requirement: 0 Lux (LED, 12 IR), shutter speed: 1/100,000(s), vibration resistant, angle of view: 120°, operating voltage: DC10-36V

47348 369,-

Replacement camera for radio rear view system 47348
473481 129,-

- Wireless, encrypted 2.4 GHz radio transmission
- Ideal for cars, motorhomes and trailers
- Viewing angle 110°, distance guide lines to the obstacle
- Monitor connection via 12 V cigarette lighter cable
- Camera for mounting on the number plate
- E24 certified

When the colour monitor is switched on, the image from the camera is sent to the monitor with a radio signal. Image transmission also possible in darkness due to built-in night vision technology

Technical data: Operating temp.: -10°C to + 50°C, transmission range: max. 10 m

Monitor: screen diagonal: 3,5"/8,9 cm, resolution: 320 x 240, dimensions: approx. 100 x 75 x 22 mm, technology: LCD-Colour display, power supply: 12 V, fuse: 1 A

Camera: resolution: 640 x 480, night vision: 7 infrared LED, viewing angle: 110°, colour sensor: ¼" colour CMOS, exposure correction/white balance: automatic, camera-tilt angle: Variable adjustable up to approx. 30°, Power supply: 12 V, IP class: IP65

Transmitter: Transmission: 2.4 GHz, Range: max. 10 m, Power supply via cigarette lighter cable

Scope of delivery: monitor, monitor holder, transmitter, camera and mounting material

47349 119,-

DIGITAL RADIO LINK FOR WIRELESS TRANSMISSION OF VIDEO SIGNALS

The reversing camera image can be transmitted wirelessly to a monitor via the radio system

The installation is carried out without laying cables and thus reduces the installation time. Operation via 12 V or 24 V possible. Radio range also suitable for larger motorhomes and caravans. Digital 2.4 GHz radio transmission
Scope of delivery: 1 receiver, 1 transmitter, incl. adapter for Carbest reversing systems. 47439 119,-



Approved for operation and use in vehicles on all European roads!



PROFIVIEW

REVERSE COMPLETE SYSTEM WITH DOUBLE LENS CAMERA AND 7" MONITOR

- 7inch professional view TFT screen with high resolution
- Camera with heater, electric shutter & wiper
- 2 lenses for close or distant view
- With infrared LEDs for optimal visibility in the dark
- Low-reflection monitor with loudspeaker and sun vis
- Sensor-controlled monitor brightness
- Automatic switch-on (when reverse gearis engaged)
- Monitor holder for gluing or screwing on
- 1 x additional AV input

Scope of delivery: 7 inch LCD -TFT colour monitor with integrated loud-speaker, joint mount and anti-glare shield. CCD colour camera in aluminium housing with integrated microphone, heater and wiper. Monitor connection cable, 20 m connection cable between camera and monitor.

47188

599,-

Technical data monitor

Screen	7 inch TFT LCD display
Resolution	480 x 234 (RGB)
TV system	PAL/NTSC
Operating temperature	-10°C to + 50°C
Operating voltage	12 Volt DC
Max. Power consumption	12 W
Camera input	1
AV output (Cinch)	1
Dimensions in mm (WxHxD)	without holder: 190x125x28
Weight	approx. 480 g

Technical data camera

Pixels	320.000 Pixel (PAL)
Angle of view Kam 1	150° diagonal, 120° H, 90° V
Viewing angle Kam 2	53° diagonal, 43° H, 32° V
Infrared night vision LED	yes
Sensitivity	0 Lux
Microphone in camera	no
Heater in camera	yes
Operating voltage	12 Volt DC / 5 W
Temperature range	-30° to + 80°C
Housing	Aluminium
Protection class	IP 68
Weight	approx. 650 g
Dimensions in mm (WxHxD)	118x57x59

REVERSING MONITOR AS REQUIRED COMBINE WITH CAMERA

Top View 7" Rear View Monitor

7" TFT monitor with a resolution of 800x480 pixels. **Can be combined with the 3 cameras 47801, 47802, 47803 listed below.** With mirror function and integrated speakers. 9 Watt power, 2 camera connections. Temperature range -10°C - +65°C. Scope of delivery: Connection cable, holder, manual and remote control.

47804 149,-

Adapter cable, for connecting a camera to navigation systems. Suitable for all cameras on this page.

47808 6,90



Van View reversing infrared camera for panel vans with split rear door

Ideal for the vehicle roof edge e.g. for panel vans and transporters with split rear door. Resolution: 500x582 pixels, 0 Lux, 9 night vision LEDs, viewing angle 120°, voltage: 12 Volt, temperature range: -20 to 70°C. Scope of delivery: camera, 20 m connection-cable, instructions and mounting material.

47803 169,-



Easy Eye Night Vision Compact Infrared Camera

Night vision compact camera with heater. Resolution: 500x582 pixels, 0 Lux, 18 night vision LEDs, viewing angle 120°, voltage: 12 Volt, temperature range: -20 to 70° C. Scope of delivery: camera, 20 m connection cable, instructions and fixing material.

47802 149,-



Full Eye rear view double camera

Double lens camera with integrated Microphone and heater. Resolution: 500x582 pixels, 0 Lux, 15 night vision LEDs, viewing angle 120°/45°, voltage: 12 Volt, temperature range: -20 to 70° C. Scope of delivery: camera, 20 m connection cable, instructions and fixing material.

47801 189,-

PROFI-VIEW REAR CAMERAS FOR RETROFITTING

- Automatically switches on when reverse gear is engaged
- AV cinch adapter for connection to all devices with cinch input
- 20 m camera cable

Approved for operation
and use in vehicles on all European roads!



Reversing camera with motor-controlled cover (shutter camera)

Cover (shutter camera)

The camera cover closes motirically and protects the camera lens from snow, water and dirt. With 20 m cable. **471894** 229,-

Camera connection adapter

For connection to existing moniceivers/naviceivers. Suitable for Carbest camera 471894 **471882** 24,99



Double lens camera with 2 lenses

Ideally suited for trailer and manoeuvring operations. With integrated windscreen wiper for a clear view and 20 m connection cable.

471888 349,-

Camera connection adapter

For connection to existing moniceivers/naviceivers. Suitable for Carbest camera 471888. **471990** 42,90

Replacement wiper

Replacement wiper for double lens camera 471888.

471880 14,49

REAR MIRROR WITH INTEGRATED MONITOR

For safe parking and manoeuvring.



For all cameras on the right side



Including connection cable



Including connection cable

Universal retaining clips

- 12 VOLT
- TOUCH SCREEN
- 4,3" LCD
- DVB-T2
- 480x272 PIXEL
- 2x VIDEO INPUT
- PAL/NTSC
- C/1
- C3.

Rear view mirror with integrated 4,3" monitor suitable for Fiat Ducato mirror base

Rear view mirror with integrated 4.3 inch monitor suitable for Fiat Ducato mirror base, automatic activation with reverse gear, auxiliary lines adjustable, 2 x video input, resolution: 480 x 272, control via touch screen, remote control, video system: PAL/AUTO/NTSC, Emark certified, Dimensions: approx. 27 x 7,5 cm

47820 149,-

Rear view mirror with integrated 4.3" monitor, universal clip-on bracket

Universal rear view mirror with integrated 4.3 inch monitor, clip-on version, automatic activation with reverse, auxiliary lines adjustable, 2 x video input, resolution: 480 x 272, control via touch screen, remote control, video system: PAL/AUTO/NTSC, Emark certified. Dimensions: approx. 27 x 7,5cm

47821 149,-

HIGH QUALITY BRAKE LIGHTS WITH INTEGRATED REAR VIEW CAMERA

- High resolution cameras
- Plug & Play installation
- Night mode with night vision IR LEDs (except 47811 + 47813)
- 10 m connection cable included
- All stop light cameras E9 certified

E9



Connection cable included with all brake light cameras

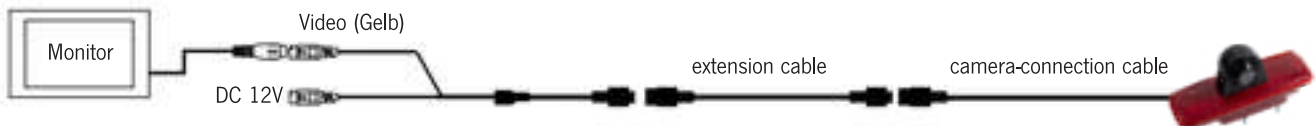

Model	① Fiat Ducato 2006-2015 3rd generation/Maxi/Peugeot Boxer/Citroen Jumper etc.	② VW Caddy	③ VW Crafter from year of manufacture 2017	④ VW T6 from model year 2016 with large tailgate	⑤ Renault Trafic/ Opel Vivaro from year of manufacture 2014 on
Camera system	1/3 CMOS	1/3 CMOS	1/3 CMOS	1/3 CMOS	1/3 CMOS
Resolution (HxV)	720x480 Pixel	960x576 Pixel	960x576 Pixel	960x576 Pixel	960x576 Pixel
TV system	PAL	PAL	PAL	PAL	PAL
Protection class	IP68	IP69	IP69	IP69	IP69
Viewpoint	160°	170°	170°	170°	120°
Horizontal resolution	600 TVL	700 TVL	700 TVL	700 TVL	700 TVL
IR LEDs	6 LEDs		9 LEDs		9 LEDs
Power supply	DC 12 V	DC 12 V	DC 12 V	DC 12 V	DC 12 V
Operating temperature	from -20°C to +70°C	from -30°C to +70°C	from -30°C to +70°C	from -30°C to +70°C	from -30°C to +70°C
Energy consumption	< 3 W	< 3 W	< 3 W	< 3 W	< 3 W
Built-in lens	2.6 mm	2.8 mm	2.8 mm	2.8 mm	2.8 mm
Emark certified	E9	E9	E9	E9	E9
Connection cable, length	10 m	10 m	10 m	10 m	10 m
Housing dimensions	approx. 26 x 5,5 cm	approx. 17,5 x 4 cm	approx. 53 x 17,5 cm	approx. 33,5 x 2,5 cm	approx. 23,5 x 7,5 cm
	47800	47811	47812	47813	47814
Price	149,-	119,-	169,-	129,-	139,-

BATTERY COOLER - COOLING WITHOUT POWER SUPPLY



12V
24V

NEW
2021

45
LITRES

DUAL-ZONE:
2 separately coolable interior compartments

Up to 20 hours cooling with Battery use



Removable battery (optional)



LCD touch display & USB port



Removable basket inserts



Lid can be moved and completely removed



100-240V AC cable available separately

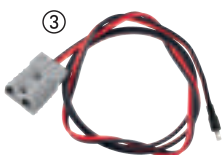

- Operation via 12/24V or via optional rechargeable battery
- Perfect when no power connection is available
- **DUAL-ZONE:** The temperature of both cooling compartments can be regulated independently from each other
- With 2 removable basket sets
- Energy-saving LED interior lighting
- Operation via LCD touch display
- Integrated USB connection
- Three-stage battery protection to protect the vehicle battery
- Lid opening freely selectable, lid completely removable
- Drain plug in the bottom of the main compartment
- Robust plastic housing with edge protection
- Integrated chopping board and cup holder

Total useful capacity (litres)	45 L
2 inner compartments (litres)	1x 32 L, 1x 13 L
Ø Current consumption	12V: 6,0A / 24V: 3,0A
Temperature range	+20 °C to -20 °C
Operating volume	< 45 dB
Dimensions (LxWxH) mm/Weight (appr.)	600 x 400 x 505/17 kg
Item number	71469
Price	499,-

Delivery of the cooler without battery and without 100-240V AC adapter cable.

- ① **100-240V AC adapter cable** enables the operation of the battery cooler with 230V voltage. **714499 19,90**
- ② **Rechargeable 15.6 Ah battery with LED battery status indicator**
Running time up to 20 hours (depending on setting) **714690 125,-**
- ③ **Solar connection cable 60 cm with 50 A high-current connector** for charging the battery via a portable solar module (For Carbest solar modules 825030 + 82506, adapter cable 850921 is also required Adapter cable 850921 is required) (For solar modules from other manufacturers, adapter cable 850922 is required) **714691 12,99**

Available from May 2021.



12V
24V

45
LITRES

35
LITRES

From now on the 230V connection cable is available separately.

POWERCOOLER COMPRESSOR COOLERS - THE HIGH-QUALITY ALL-ROUNDER

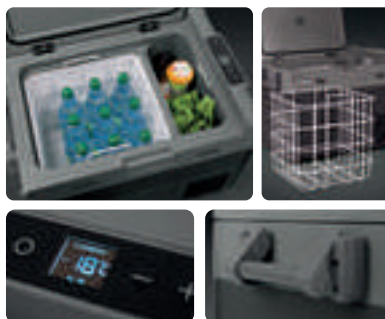

- Cooling capacity -18°C to +10°C
- Robust housing with sturdy carrying handles
- Integrated lashing eyes for fastening of a carrying strap
- Electric thermostat with digital temperature display
- Three-stage battery protection to protect the vehicle battery
- Color: Black/Grey

Product	PowerCooler 35	PowerCooler 45
Useful capacity (litres)	Refrigerator/freezer 4.5 L/30.5 L	Refrigerator/freezer 7.0 L/38 L
Supply voltage	12/24 Volt DC	
Ø Power consumption	12V: 55W, 4,6A / 24V: 55W, 2,3A	12V: 65W, 5,4A / 24V: 65W, 2,7A
Temperature range	+10 °C to -18 °C	
Noise emission	45 dB	
Dimensions (L x W x H) mm	650 x 400 x 395	650 x 400 x 465
Weight approx.	17,1 kg	18,5 kg
Item number	714102	714103
Price	419,-	489,-



100-240V AC adapter cable allows the coolers to be operated with 230V voltage **714101 29,90**

THE NEW COMPRESSOR COOLER SERIES FOR CAMPING, OUTDOOR AND LEISURE

- Cooling and freezing from -20°C to +10°C
- Robustly constructed with reinforced handles and base corners -
- Digital control panel and LED interior lighting
- Integrated battery protection

The new powerful compressor coolers from Carbest offer a cooling capacity down to -20°C. The temperature is set via a digital control unit and can be selected between the MAX or ECO power settings. The removable basket insert in the main compartment allows for easy cleaning. The 12/24V connection cable is included, the 100-240V AC adapter cable is available separately



Model	35 liters	45 liters	55 liters
Useful capacity (litres)	35 L	45 L	55 L
Temperature range	+10 °C to -20 °C		
Supply voltage	12/24 Volt DC		
Ø Current consumption	12V: 5,0A / 24V: 2,5A		
Noise emission	< 45 dB		
Dimensions (L x W x H) mm	690x345x382	690x345x462	690x345x524
Weight (approx.)	12,1 kg	12,9 kg	13,8 kg
Item number	71456	71457	71458
Price	379,-	429,-	499,-

100-240V AC adapter cable, enables operation of the coolers with 230V voltage

714499 19,90

Available from April 2021.



MOUNTING PULL-OUTS FOR COOL BOXES

- Loadable up to max. 120 kg
- Extension rail M with approx. 760 mm extension, for coolers with a size of max. LxW 740x410 mm
- Extension rail L with approx. 900 mm extension, for coolers with a size of max. LxW 910x530 mm
- Solid, powder-coated metal frame
- Safety lock
- Including 4 lashing straps and mounting material

Thanks to the universal pull-out rails, your cooler can be pulled out of the vehicle for convenient loading and unloading. A safety lock ensures that the rail is firmly anchored in the pushed-together position during the journey.

Scope of delivery: Fixing pull-out, 4 lashing straps with which the cool box can be secured (to lashing eyes) on the pull-out frame, assembly material. (Supplied without cool box)

Universal pull-out rail M - loadable up to 120 kg

Dimensions (LxWxH) outside: 790x480x65 mm, inside: 740x410 mm Weight: approx. 12.8 kg 71498 199,-

Universal pull-out rail L - loadable up to 120 kg

Dimensions (LxWxH) Outside: 960x600x65 mm, Inside: 910x530 mm Weight: approx. 16 kg 71499 219,-

Available from April 2021.



MAXIFREEZER

PROFESSIONAL COMPRESSOR COOLERS

12V
24V
230V



Thermal protection bag optionally available (except 71375).

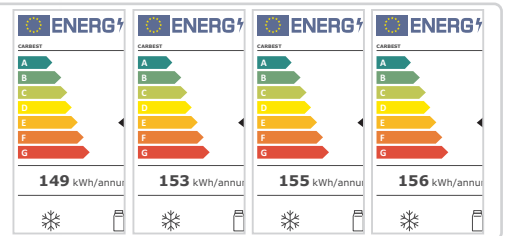

- Extremely robust housing with edge protection
- 2 sturdy carrying handles (loadable up to 140 kg)
- Removable lid, can be opened on both sides
- Easy cleaning thanks to removable basket insert
- Electric thermostat with digital temperature display
- Reliable, low-noise compressor
- Battery monitor to protect the vehicle battery
- Energy-saving LED interior lighting
- Easy operation via LED display
- Scope of delivery: cooler, connection cable, operating instructions
- Thermal bag optionally available (except 71375)

Model	MaxiFreezer 28	MaxiFreezer 40	MaxiFreezer 50	MaxiFreezer 60
Useful capacity (litres)	Refrigerator/freezer compartment 4/22	Refrigerator/freezer compartment 7/33	Refrigerator/freezer compartment 9/41	Refrigerator/freezer compartment 12/46
Supply voltage	12/24 Volt DC, 220-240 Volt AC			
Ø Current consumption	DC 12 V/3.2 A DC 24 V/1.6 A	12 V/4.2 A 24 V/2.2 A 220-240 V/0.4 A	12 V/4.2 A 24 V/2.2 A 220-240 V/0.4 A	12 V/4.2 A 24 V/2.2 A 220-240 V/0.4 A
Temperature range	+10 °C to -16 °C	+10 °C to -20 °C		
Energy class as of 03/2021	F			
Color	Matte Black/Matte Blue			
Dimensions (L x W x H)	594 x 381 x 373 mm	712 x 452 x 440 mm	714 x 447 x 467 mm	713 x 454 x 523 mm
Weight (approx.)	13 kg	20 kg	22 kg	23 kg
Item number	71375	71371	71372	71373
Price	469,-	599,-	679,-	779,-

Thermal bag for MaxiFreezer 40, 50 and 60

Item number	-	713710	713720	713730
Price	-	49,90	54,99	59,90

Connection cable UK for MaxiFreezer 40, 50 and 60
713711 6,90



Delivery without contents

COMPRESSOR COOLERS FOR THE CAB



9
LITRES



i From now on the 230V connection cable is available separately.



16
LITRES



i From now on the 230V connection cable is available separately.

For VW T5 / T6

12 V
24 V
230 V

9 litre compressor cooler VAN S

- Fits between driver's seat and passenger seat VW T5/T6
- With cup holder, interior light and ice cube tray
- Incl. carrying strap and 2 lashing points for fastening

Ø Power input 35 watts .Connection: 12, 24 and 230 V, temperature range: +10°C to -18°C, dimensions: W x D x H 210 x 459 x 320 mm Weight: approx. 8,5 kg. **713541 419,-**

220-240 V adapter cable

Allows the cooler to be operated with 230V voltage

713540 29,90



For Fiat Ducato

12 V
24 V
230 V

16 litre compressor cooler VAN M

- Fits between driver's seat and passenger seat Fiat Ducato
- With interior light & ice cube tray
- Carrying strap included

Ø Power input: 40 watts . Ø Powerconsumption: approx. 0.35 - 0.53 kwh, connection: 12, 24 and 230 V .temperature range: +10°C to -18°C ,dimensions: W x D x H approx. 230 x 532 x 384 mm, weight: approx. 10 kg, **713542 459,-**

220-240 V adapter cable

Allows the cooler to be operated with 230V voltage

713540 29,90



POWERFUL ABSORPTION COOLER

- Standing height for 15x 1 litre bottles
- 2 lashing eyes for fastening with tension belts
- Stepless flame regulation in gas operation
- Stepless themostatic control in 230V operation
- With integrated spirit level for optimal alignment
- Practical recessed grips for easier transport

Ø Power input: 90 watts Connected loads 12 volts, 7,5 A, 230 volts / 50 Hz, 0.35 A

Gas operation 30 mbar or 50 mbar.

Temperature range: +5°C to +10°C (20°C-25°C below ambient temperature)

Volume: 38 L

Dimensions: W 500 x D 470 x H 440 mm

Weight: approx. 18 kg

30 mbar **713581 249,-**
50 mbar **71358 249,-**

12V
24V
230V

30
mbar

50
mbar



38
LITRES

Delivery without contents

CV50L

COMPACT COMPRESSOR BUILT-IN REFRIGERATOR FOR CAMPERVANS AND VANS



- Powerful, low-noise compressor
- Operation via LED display
- Particularly economical LED interior lighting
- Installation frame available separately

The temperature can be regulated via an LED display, which is flush-mounted in the inner wall of the refrigerator. Integrated LED lighting in the interior. Door hinged on the right (cannot be moved)

Ø Power consumption: 40 watts
 Temperature range refrigerator: +5°C to +15°C
 Temperature range freezer compartment: max. -18°C
 Volume total/refrigerator/freezer: 46,5/42/4,5 L
 Dimensions: W 380 x D 490 x H 530 mm
 Weight: approx. 17 kg **713572 679,-**



Also order

Matching mounting frame Material: aluminium, colour silver metallic
7135720 52,-



Available from March 2021. Delivery without contents.

40 L REFRIGERATOR WITH STAINLESS STEEL FRONT



40
LITRES

12 V
24 V

- Simple operation due to external
- LED display on the outside
- Freezer compartment with ice cube maker
- High-quality stainless steel front

By 180 cm long hose the compressor unit can be installed off-set to the refrigerator.

Ø Power consumption: 45 watts
 Temperature range refrigerator: 0°C to +10°C
 Temperature range freezer compartment: max. -12°C
 Volume total/refrigerator/freezer: 40/34/6 L
 Dimensions: W 380 x D 338/508 x H 510 + 30 feet mm
 Weight: approx. 15 kg **71357 699,-**

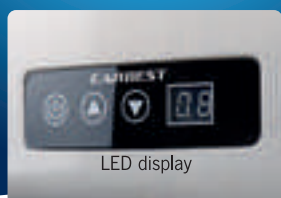

Approx. 180 cm long connection between compressor unit and refrigerator.

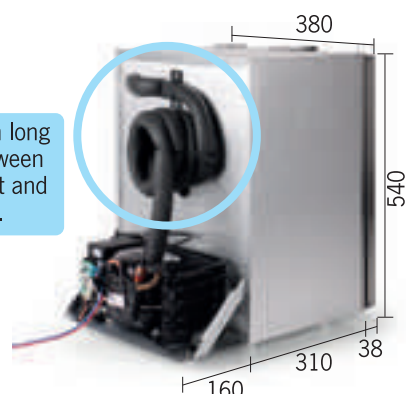

BUILT-IN COMPRESSOR REFRIGERATORS – WITH INTEGRATED COOLING BATTERIES IN THE WALLS

- Freezer packs integrated into the walls, not visible
- Economical operation in night mode
- LED display with touch control
- Fast cooling down thanks to boost function
- Door hinge left or right freely selectable

87 litre refrigerator especially for panel vans

The narrow design with a width of 419 mm is specially adapted to the shape of panel vans. (Invisible) cooling batteries have been integrated into the side/rear walls, which have enough capacity to interrupt the cooling operation overnight.

Model	87 liters
Gross volume	87 Ltr.
Refrigerator/freezer	76,5 Ltr. / 10,5 Ltr.
Temperature range Refrigerator/freezer	+3°C to +10°C / max. -18°C
Door stop	Left or right
Color	Black matt
Dimensions (WxHxD) mm	419 x 975 x 485
Weight approx.	23 kg
Item no.	713501
Price	899,-



128 litre refrigerator with relocatable compressor unit ideal for motorhomes

Large compressor refrigerator with a total volume of volume of 128 litres. Through a 150 cm long Between the compressor unit and the refrigerator the compressor unit can be installed offset. This reduces the installation depth. In the side/rear walls (invisible) cooling accumulators have been integrated, which have enough capacity to interrupt the cooling operation over night.

Model	128 litres
Gross volume	128 Ltr.
Refrigerator/freezer	114 Ltr. / 14 Ltr.
Temperature range Refrigerator/freezer	+3°C to +10°C / max. -16°C
Door stop	Left or right
Color	Black matt
Dimensions (WxHxD) mm	419 x 1523 x 565
Weight approx.	30 kg
Item no.	713502
Price	1199,-



Compressor unit can be moved thanks to 150 cm long supply line between compressor unit and refrigerator. **Only for 128 litre model.**



COOLING & HEATING WITH 2500 OR 3300 WATT. THE NEW CARBEST ROOF AIR CONDITIONERS



**NEW
2021**

White Matt



**NEW
2021**

Black Matt



Air distribution unit with LED touch display

- Cooling and heating in one unit
- Air distribution unit included
- Easy control via remote control or LED touch display on the air distribution unit
- Aerodynamic due to very flat design
- Powerful and yet very quiet in operation

With the new roof air conditioners from Carbest you not only cool the living space in your motorhome or caravan on hot days, but thanks to the heating function you can also enjoy a cosy warmth in your vehicle on cold days.

The 2500 watt air conditioner is suitable for vehicles up to 7m in length. The 3300 watt unit is suitable for vehicles over 7m in length

The air conditioners consist of a white or black outdoor unit and a white air distributor unit (dimensions: LxW 540x490 mm). The air distributor can be controlled via the touch display or conveniently by remote control.

Technical data	2500 watts	3300 Watt
Cooling capacity / Heating capacity	2500 / 2600 W	3300 / 3400 W
Input voltage	220-240 V/50 Hz	220-240 V/50 Hz
Power consumption cooling/heating mode	4,6 A/3,7 A	6,3 A/5,3 A
Dimensions outdoor unit (L x W x H)	1056x736x253 mm	1056x736x253 mm
Dimensions air distributor (L x W x H)	540x490x72 mm	540x490x72 mm
Roof cut-out dimension	400x400 mm	
Roof thickness	26-100 mm	
Weight incl. air distribution unit	approx. 45 kg	approx. 49 kg
Colour White Matt	495003 1490,-	495004 1699,-
Color Black Matt	4950031 1590,-	4950041 1799,-

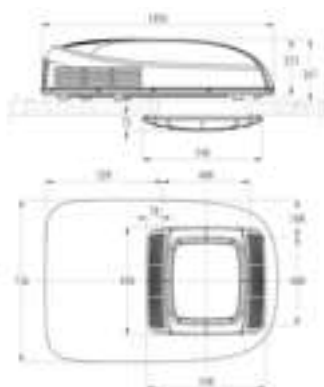

VanHeat

POWERFUL 12 V DIESEL PARKING HEATERS VANHEAT 2.0-DH AND VANHEAT 4.0-DH

- Powerful with 2 kW or 4 kW heating capacity
- Integrated altitude adjustment up to 5,000 m
- Control via digital operating panel
- Remote control optionally available
- Compact design and robust housing
- Both units are Emark certified

The compact parking heaters from Carbest provide cosy warmth in your vehicle through the combustion of diesel fuel. The control takes place via a digital control element, radio remote control for switching the device ON / OFF from a distance optionally available. Installation material is included in the scope of delivery (see pictures scope of delivery). The altitude adjustment (alpine kit) is already integrated in the housing and thus allows a frictionless operation in the high mountains up to 5,000 m.

The parking heater with a heating capacity of 2 kW is ideally suited for vans, camping buses and smaller motorhomes. The parking heater with a heat output of 4 kW is ideally suited for larger camping buses and motorhomes. Both parking heaters have a type approval according to UN ECE R122.



**NEW
2021**

2 kW

Altitude adjustment up to 5.000 m

4 kW

Altitude adjustment up to 5.000 m



**NEW
2021**

Images similar

Radio remote control for Carbest parking heaters

Convenient control of the Carbest parking heaters radio remote control. Range up to 1,000 m. Power supply via 12V DC, frequency range: 868 MHz. Scope of delivery: Hand-held transmitter (IP68), receiver and external antenna (antenna not shown)

48014

279,-



Scope of delivery 2 kW parking heater



Scope of delivery 4 kW parking heater

Heating type	① Diesel parking heater 2 kW	② Diesel parking heater 4 kW
Heating cable	2000 W	4000 W
Rated voltage	12 Volt DC	12 Volt DC
Ø Power consumption (approx.)	10 - 29 W	8 - 34 W
Fuel	Diesel	Diesel
Fuel consumption (approx.)	0.12 - 0.24 l/h	0.11 - 0.51 l/h
Dimensions (LxWxH)	315x120x121 mm	380x140x150 mm
Weight heater (approx.)	2,6 kg	4,5 kg
Item number	48182	48183
Price	649,-	699,-



HEIGHT-ADJUSTABLE TABLE AND STAND FAN WITH RECHARGEABLE BATTERY

- Wireless - battery life up to 20 hours
- Rechargeable battery: 3.7 V / 7,200 mAh
- Infinitely height adjustable up to 100cm
- Compact pack size
- 3 speed levels + interval mode

This versatile fan scores first and foremost with its compact pack size. The wireless device is powered by a rechargeable battery and charged by the included USB cable. It has a telescopic stand and is continuously adjustable in height from 36 - 100 cm. The different speed levels have run times of level 1: max. 20 hrs, level 2: max. 8 hrs, level 3: max. 4 hrs. Operation in the additional interval stage max. 13 hrs. Material: ABS/aluminium/PP.

Pack size: Ø20 x height 9,5 cm, weight: approx. 1 kg
462888 49,99



12 V FAN

- For cooling on hot days
- Cable length 2.5 m
- Clamp mount

Ø fan: 18 cm, fastening with clamp, Dimensions approx. H 25cm, D 20 cm. Material: PP/metal
 Weight 0,7 kg.

462880 20,90



POWERFUL 230 V HEATERS

① Fan heater in chic design

With 2 power levels: 750/1500W, 230V. 12h timer and LED display. Automatic tilt protection - switches off the power supply immediately if it falls over. Temperature control and overheating protection.

Dimensions: W220 x H290 x D120 mm, weight approx.: 1.8 kg. **811527 41,90**

② Ceramic heater Ivalo

With 2 power settings: 750/1500W, 230 V. Self-rotating (oscillating). With overheating protection and automatic tilt protection - switches off the power supply immediately if it falls over. Dimensions: H260 x W200 x T130 mm

811522 29,90

③ Ceramic fan heater Mika

- 2 functions: Heating/ventilation
- Double overheating protection
- Low noise operation

With 2 power levels: 750/1500W, 230 V. Optionally can be switched to heating or ventilation. Adjustable thermostat for temperature control and setting. Automatic tilt protection - switches off the power supply immediately if it falls over. With power indicator. Safety ceramic heating element. CE-approved

Approx. dimensions: B215 x H220 x D223 mm, approx. weight: 2 kg

811525 33,99



REAL- GLASS- WINDOWS.

FOR RETROFITTING
OR AS A REPLACEMENT WINDOW.

Good views with the Carbest real glass windows for campervans, vans and motorhomes.

The retrofittable safety glass windows give your vehicle a noble character, increase the living atmosphere in the vehicle and visually turn a van into an estate model. The dark-tinted glazing ensures that your privacy is maintained in the best possible way.

Many window models are available as sliding windows and thus provide not only a lot of light but also fresh air in the vehicle.

For many different manufacturers and vehicle types available. Increase the value of your vehicle and upgrade your motorhome now!

TINTED SAFETY GLASS WINDOWS FOR VW T5/T6 AND VW CADDY



Sliding window for VW T4 My. 1990-2004

Position	Total measure W x H	Weight	Item no.	Price
Front Right, kR + IR	1126 x 523 mm		31503	184,90
Front Left, kR + IR	1126 x 523 mm		31504	184,90

Rigid windows for VW T4 My. 1990-2004

Position	Total measure W x H	Weight	Item no.	Price
Rear Right, kR	967 x 522 mm		31505	84,90
Rear Left, kR	967 x 522 mm		31506	84,90

Sliding window for VW T5/T6 from 2004 onwards

Position	Total measure W x H	Weight	Item no.	Price
Front Right, kR	1135 x 585 mm	7,5 kg	31591	184,90
Front left, kR	1135 x 585 mm	7,5 kg	31590	184,90

Position	Total measure W x H	Weight	Item no.	Price
Rear Right, kR	922 x 572 mm	6.0 kg	315911	184,90
Rear Left, kR	922 x 572 mm	6,5 kg	315900	184,90
Rear Right, IR	1257 x 570 mm	9,5 kg	315912	184,90
Rear Left, IR	1257 x 570 mm	9,5 kg	315901	184,90

Rigid windows for VW T5/T6 from 2004 onwards

Position	Total measure W x H	Weight	Item no.	Price
Front Right, kR+IR	1135 x 585 mm	7,0 kg	315910	84,90

Position	Total measure W x H	Weight	Item no.	Price
Rear Right, kR	922 x 572 mm	5.0 kg	31599	84,90
Rear Left, kR	922 x 572 mm	5.0 kg	31598	84,90
Rear Right, IR	1257 x 570 mm	8,0 kg	315990	84,90
Rear Left, IR	1257 x 570 mm	8,0 kg	315980	84,90

Tailgate window rigid for VW T5 My. 2004-2016

Position	Total measure W x H	Weight	Item no.	Price
NEW: Rear kR + IR	1445 x 575 mm	10.0 kg	316005	204,-

Tailgate window rigid for VW T6 from 2016 onwards

Position	Total measure W x H	Weight	Item no.	Price
Tailgate, kR + IR	1554 x 562 mm	10.0 kg	31600	199,-

AIRvent ventilation grille for CARBEST VW T5/T6 sliding window



With completely surrounding rubber piping for perfect sealing of the window.
 Left, suitable for 31590 **461600 129,-**
 Right, suitable for 31591 **461601 129,-**

Rigid windows for VW Caddy My. 2009-2020

Position	Total measure W x H	Weight	Item no.	Price
NEW: Front right, kR	714 x 538 mm	5.0 kg	316021	65,90
NEW: Front left, kR	714 x 538 mm	5.0 kg	316020	65,90

Position	Total measure W x H	Weight	Item no.	Price
NEW: Rear Right, kR	1044 x 545 mm	6,5 kg	31605	84,90
NEW: Rear left, kR	1044 x 545 mm	6,5 kg	31604	84,90

Sliding window for VW Caddy My. 2009-2020

Position	Total measure W x H	Weight	Item no.	Price
NEW: Front right, kR	714 x 538 mm	6.0 kg	31618	184,90
NEW: Front left, kR	714 x 538 mm	6.0 kg	31617	184,90

Rear window rigid for VW Caddy My. 2004-2016

Position	Total measure W x H	Weight	Item no.	Price
NEW: Tailgate, kR	1257 x 591 mm	9,0 kg	316024	179,-

Rear window rigid for VW Caddy My. 2015-2020

Position	Total measure W x H	Weight	Item no.	Price
NEW: Tailgate, kR	1377 x 588 mm	9,0 kg	316025	179,-

TINTED SAFETY GLASS WINDOWS FOR MERCEDES VITO

Rigid windows for MB Vito My. 2004-2014

Position	Overall dimension W x H (mm)	Weight	Item no.	Price
Front Right, kR + IR	1096 x 565	7,0 kg	31511	84,90
Front Left, kR + IR	1096 x 565	7,0 kg	31510	84,90
Rear Right, kR	1169 x 521	7,0 kg	31523	89,90
Rear Left, kR	1169 x 521	7,0 kg	31522	89,90
Rear Right, IR	1296 x 521	7,5 kg	31513	89,90
Rear Left, IR	1296 x 521	7,5 kg	31512	89,90

Sliding window for MB Vito My. 2004-2014

Position	Overall dimension W x H (mm)	Weight	Item no.	Price
Front Right, kR + IR	1096 x 565	9,0 kg	31521	184,90
Front Left, kR + IR	1096 x 565	9,0 kg	31520	184,90

Sliding window for MB Vito from year 2015

Position	Overall dimension W x H (mm)	Weight	Item no.	Price
Front Right, kR + IR	1100 x 570	5.0 kg	31597	184,90
Front Left, kR + IR	1100 x 570	5.0 kg	31596	184,90

Rigid windows for MB Vito from 2015 model year

Position	Overall dimension W x H (mm)	Weight	Item no.	Price
Rear Right, mR (5.14m)	1195 x 531	7,5 kg	315970	84,90
Rear Left, mR (5.14m)	1195 x 531	7,5 kg	315960	84,90

Images similar



TINTED SAFETY GLASS WINDOWS FOR CITROËN JUMPY 3/SPACETOURER, PEUGEOT EXPERT 3/TRAVELLER, TOYOTA PROACE 2/PROACE VERSO AND OPEL VIVAROC/ZAFIRA LIFE, as of 2016

Sliding window

Position	Overall dimension W x H (mm)	Weight	Item no.	Price
Front Right	1100 x 541	8,5 kg	31701	239,-
Front left	1100 x 541	8,5 kg	31700	239,-

You will find many more Carbest windows on our homepage:
www.reimo.com



VEHICLE-SPECIFIC, TINTED SAFETY GLASS WINDOWS

- Dark tinted real glass windows for replacement or retrofitting
- For common vehicle models
- Provides fresh air in the vehicle
- With installation instructions

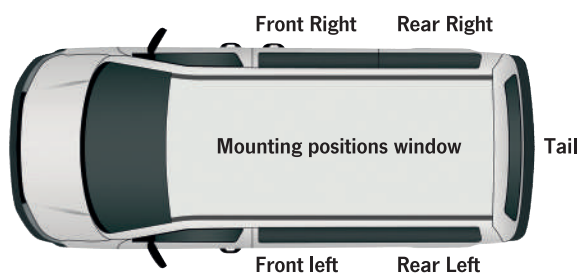

Window cut-out results from the embossing in the vehicle wall

Sliding window for Ford Transit Custom from Bj. 7/2013

Position	Overall dimension W x H	Weight	Item no.	Price
Front Right, kR + IR	1199 x 566 mm	7,0 kg	31595	184,90
Front Left, kR + IR	1208 x 566 mm	7,0 kg	31594	184,90

without illustration

Sliding windows for Renault Trafic

Position	Bj.	Overall dimension W x H	Weight	Item no.	Price
Front Right, kR + IR	02-15	1193 x 665 mm	9,0 kg	316012	184,90
Front Left, kR + IR	02-15	1193 x 665 mm	9,0 kg	316011	184,90
Front Right, kR + IR	from 15	1116 x 598 mm	7,5 kg	31593	204,-
Front Left, kR + IR	from 15	1116 x 598 mm	7,5 kg	31592	204,-

Rigid windows for Renault Trafic

Position	Bj.	Overall dimension W x H	Weight	Item no.	Price
Rear Right, kR	from 15	919 x 571 mm	8,0 kg	31602	79,90
Rear Left, kR	from 15	919 x 571 mm	8,0 kg	31601	79,90
Front Right, kR	from 15	1116 x 598 mm	7,0 kg	316010	89,90
NEW: Rear door left	02-19	670 x 623 mm	6,0 kg	315913	87,90
NEW: Rear door right	02-19	670 x 623 mm	6,0 kg	315914	87,90



Real glass windows from Carbest

The dark tinted safety glass windows give the vehicle a noble character, visually turn the box into a station wagon and are suitable for replacement and retrofitting. Many windows are available as sliding windows and bring fresh air into the vehicle. Installation instructions are included.

Recommended accessories:

① Edge protector	294541	15,99
② Cleaner	29415	21,95
③ Adhesive set (you need 2x per window)	294841	32,30
② + ③ Window accessories set (2x glue set + cleaner)	294000	82,90



①



②



③



Images similar

TINTED SAFETY GLASS WINDOWS FOR MAXI VANS

NEW: Sliding window for VW Crafter >2018

Position	Overall dimension W x H	Weight	Item no.	Price
Front Right	1492 x 713 mm	13,5	31710	224,-
Front left	1488x 713 mm	13,5	31711	224,-
Position				
Center Right	1455 x 637 mm	13,0	31712	224,-
Center Left	1455 x 702 mm	13,5	31713	224,-
Position				
Rear Right	883 x 682 mm	8,5	31714	219,-
Rear Left	883 x 682 mm	8,5	31715	219,-

NEW: Rigid rear windows for VW Crafter >2018

Position	Overall dimension W x H	Weight	Item no.	Price
Rear door right	776 x 649 mm	6,5	31716	109,-
Rear door left	776 x 649 mm	6,5	31717	109,-

For Fiat Ducato, Peugeot Boxer, Citroën Jumper >2007

Sliding window position	Overall dimension W x H	Weight	Item no.	Price
Front Right, L2 / L4 / L5	1400 x 665 mm	10.0 kg	31619	189,-
Front Left, L2 / L4 / L5	1434 x 665 mm	10.0 kg	31620	189,-
Center Right, L2 / L4 / L5	1360 x 585 mm	9,0 kg	31622	189,-
Center Left, L2 / L4 / L5	1360 x 665 mm	9,0 kg	31621	189,-
Rear Right, L5	1126 x 665 mm	8,5 kg	31623	184,90
Rear Left, L5	1128 x 665 mm	8,5 kg	31624	184,90

Vehicle lengths:

L2 = 541 cm / L4 = 599 cm / L5 = 636 cm

Rigid window position	Overall dimension W x H	Weight	Item no.	Price
Front Right	1400 x 665 mm	9,5 kg	316190	99,-
NEW: Front left1	1434 x 665 mm	10 kg	316200	99,-
NEW: Center left2	1360 x 665 mm	9,5 kg	316210	99,-
NEW: Center right2	1360 x 585 mm	9 kg	316220	99,-
NEW: Rear right3	1128 x 665 mm	8 kg	316230	99,-
NEW: Rear left3	1128 x 665 mm	8 kg	316240	99,-

Rear window position	Overall dimension W x H	Weight	Item no.	Price
Rear door right	826 x 665 mm	5.0 kg	31625	79,90
Rear door left	826 x 665 mm	5.0 kg	31626	79,90
NEW: Rear door right*	826 x 665 mm	5 kg	31627	79,90
NEW: Rear door left*	826 x 665 mm	5 kg	31628	79,90

* With recess for the 270° door hinges

¹For models 15M3/13M3/11M3

²Formodels 15M3/13M3

³Formodels 15M3

Sliding window for Mercedes Sprinter Bj 2007-2018

and identical vehicles (VW Crafter Bj 2007-2018)

Position	Overall dimension W x H	Weight	Item no.	Price
Front Right, kR + IR	1405 x 766 mm	13,5 kg	315002	229,-
Front Left, kR + IR	1408 x 766 mm	13,5 kg	315003	229,-

Rigid window for Mercedes Sprinter Bj 2007-2018

and similar vehicles (VW Crafter Bj 2007-2018)

Position	Overall dimension W x H	Weight	Item no.	Price
Center Right, kR + IR	1416 x 706 mm	12.0 kg	315001	119,-
Center Left, kR + IR	1422 x 766 mm	12.0 kg	315000	119,-

Images similar

Rear window for Mercedes Sprinter My. 2007-2018

and identical vehicles (VW Crafter Bj. 2007-2018)

Rear window for Mercedes Sprinter from year 2019

Position	Overall dimension W x H	Weight	Item no.	Price
Rear door right	775 x 775 mm	7,0 kg	315006	119,-
Rear door left	775 x 775 mm	7,0 kg	315007	119,-

Images similar

**NEW
2021**



MOTORHOME WINDOWS RW-SERIES WITH ALUMINIUM FRAME AND REAL GLASS PANES



Real glass vent window - RW ECO

- 3.5 mm safety glass with dark tinting
- For wall thickness 30 mm, corner radius 75 mm
- With telescopic shutters



Windows						Interior roller blind with frame	
Cut-out dimension W x H (mm)	Overall dimension W x H (mm)	Opening angle	Weight	Item no.	Price	Item no.	Price
350 x 500	397 x 554	54°	2,7 kg	31880*	114,90	318801	71,99
500 x 300	547 x 354	26°	2,6 kg	31881**	107,90	318811	69,99
500 x 450	547 x 504	45°	3,3 kg	31882*	134,90	318821	79,99
700 x 300	747 x 354	26°	3,4 kg	31883**	134,90	318831	85,99
800 x 450	847 x 504	45°	5,2 kg	31884*	199,-	318841	94,99
900 x 450	947 x 504	45°	5,9 kg	31885*	202,-	318851	96,99
900 x 500	947 x 554	54°	6,3 kg	31886*	204,-	318861	99,99
1000 x 500	1047 x 554	54°	6,8 kg	31887*	213,90	318871	104,99

* Stainless steel telescopic display unit, infinitely variable ** Plastic display unit, 3-stage

Sliding glass windows - RW MOTION

- Best insulation due to double glazing
- Powder coated high quality aluminium frame
- Tinted safety glass pane
- For wall thickness 30 mm, corner radius 87 mm

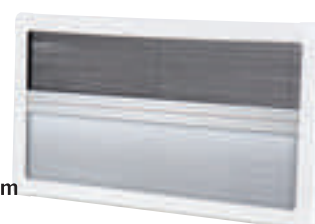

Windows					Interior roller blind with frame	
Cut-out dimension W x H (mm)	Cut-out dimension W x H (mm)	Weight	Item no.	Price	Item no.	Price
500 x 350	528 x 378	5,9 kg	31650	127,90	316501	69,99
500 x 450	528 x 478	6,5 kg	31654	165,90	316541	71,99
600 x 350	628 x 378	6,2 kg	31653	149,90	316531	69,99
800 x 340	828 x 368	7,8 kg	31656	169,90	316561	88,99
800 x 400	828 x 428	8,3 kg	31651	167,90	316511	87,99
800 x 450	828 x 478	9,9 kg	31655	185,90	316551	88,99
960 x 450	988 x 478	10,9 kg	31652	182,90	316521	89,99

FRAME WITH BLACKOUT & INSECT SCREEN FOR CARBEST MOTOR-HOME WINDOWS



Interior roller blind with frame - RW STYLE

• Aluminium, mosquito net and blackout

Wide	Height	Item no.	Price
500	350	3180000	65,-
500	450	3180010	70,-
700	400	3180020	79,-
900	450	3180030	90,-
1000	800	3180040	115,-
1100	450	3180050	105,-
1200	300	3180060	99,-
1200	500	3180070	110,-
1450	550	3180080	115,-

Interior roller blind with frame - RW COMPACT

• Aluminium, mosquito net and blackout

Wide	Height	Item no.	Price
350	500	318901	74,99
500	300	318911	73,99
500	450	318921	76,99
600	450	318991	84,99
700	300	318931	89,99
700	400	319001	89,99
800	450	318941	99,99
900	450	318951	97,99
900	500	318961	107,-
1000	500	318971	109,-

Interior roller blind with frame for panel van - RW V

• Aluminium, mosquito net and blackout

Breite	Höhe	Art. Nr.	Preis
280	380	319111	84,99
490	500	319121	109,-
600	450	319171	94,99
750	455	319131	129,-
818	315	319141	109,99
985	465	319151	134,99
900	400	319181	124,99
900	450	319161	124,99
960	450	319101	129,-



Interior roller blind with frame - RW ECO

• Aluminium, mosquito net and blackout

Wide	Height	Item no.	Price
350	500	318801	71,99
500	300	318811	69,99
500	450	318821	79,99
700	300	318831	85,99
800	450	318841	94,99
900	450	318851	96,99
900	500	318861	99,99
1000	500	318871	109,99

Interior roller blind with frame - RW MOTION PVC, mosquito net and blackout

Wide	Height	Item no.	Price
500	350	316501	69,99
500	450	316541	71,99
600	350	316531	69,99
800	340	316561	88,99
800	400	316511	87,99
800	450	316551	88,99
960	450	316521	89,99

Interior roller blind with frame for e.g. Fiat Ducato - RW REAR

• Aluminium, mosquito net and blackout

Wide	Height	Item no.	Price
340	650	319201	89,99
700	650	319211	96,90
815	650	319221	104,99
1050	650	319231	107,99

ROOF LIGHT INCLUDING BLACKOUT & MOSQUITO PROTECTION



40x40 cm

- UV-resistant roof light in 40x40 cm format
- With high-quality pleated roller blind with magnetic closure, blackout and mosquito protection
- Dark tinted, construction height: approx. 9 cm
- With night lock
- Maximum opening up to 70°
- Ready for installation: Is glued to the vehicle roof and screwed from the inside
- 2 openers for safe and even opening
- With inner frame, without forced ventilation

31888 119,90

TIPP

We generally recommend the installation of front spoilers

POWER VENT ROOF HOOVES

- UV-resistant
- Integrated insect screen
- Manual opening and closing
- Maximum opening up to 50°
- For roof thicknesses from 25-80 mm
- Cut-out size: 280x280 mm
- Overall dimension: 365x365 mm

Power Vent without 12 V fan

Hood: Crystal (frosted glass look)

Weight: approx. 2,1 kg **318530 63,90**

Power Vent with 12 V fan

Technical data fan:

Power: 9.6W, capacity 9^{m3/h}

Noise level ≤ 50dB, Ø 175 mm,

5 fan blades, hood: white (opaque)

Weight: approx. 2.3 kg **31853 84,90**

28x28 cm

12V

28x28 cm



HIGH QUALITY ROOF LIGHTS

- Double glazed and UV resistant
- Integrated blackout system
- Integrated insect screen
- Built-in LEDs and switch
- Maximum opening up to 60°
- Easy operation with gas springs
- For roof thicknesses from 25-60 mm

Panorama roof hood 70x50 cm

Cut-out size: 702x502 mm

Total size: 833x633 mm

Hood: tinted acrylic glass, weight: approx. 8.0 kg

Without forced ventilation 31854 414,50

With forced ventilation 318540 419,-

Roof hood 45x40 cm

Cut-out dimension: 452x402 mm

Overall dimensions: 577x577 mm

Hood: tinted acrylic glass, weight: approx. 5.5 kg

Without forced ventilation 31851 249,90

With forced ventilation 318510 259,90

70x50
45x40
cm



Integrated insect screen and blackout system in the inner frame.

4 integrated LED lights in the inner frame with ON/OFF switch.

HIGH QUALITY ROOF LIGHTS IN NEW DESIGN



- In 2 sizes: 70x50 or 45x40 cm
- Double glazed dome surface
- Integrated blackout system
- Integrated insect screen
- Built-in LEDs
- Maximum opening up to 60
- Easy operation with gas springs
- For roof thicknesses of 25-60 mm
- Roof hood height 90 mm

① Panorama roof hood 70x50 cm

Cut-out dimension: 702x502 mm

Total dimension: 818x617 mm

Without forced ventilation, with LED

31878 395,-

With forced ventilation, with LED

318780 419,-

② Roof hood 45x40 cm

Cut-out dimension: 452x402 mm

Overall dimension: 577x577 mm

Without forced ventilation, with LED

31877 264,-

With forced ventilation, with LED

318770 279,-

①
70x50
cm



②
45x40
cm

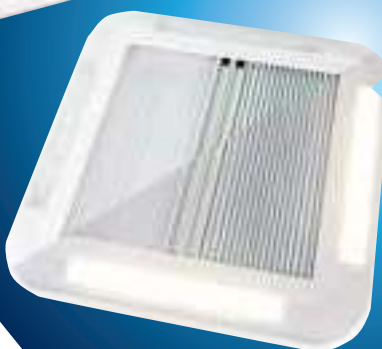

Integrated insect screen and blackout system in the inner frame.

4 integrated LED lights in the inner frame with ON/OFF switch.



12V LED LINE LIGHTS

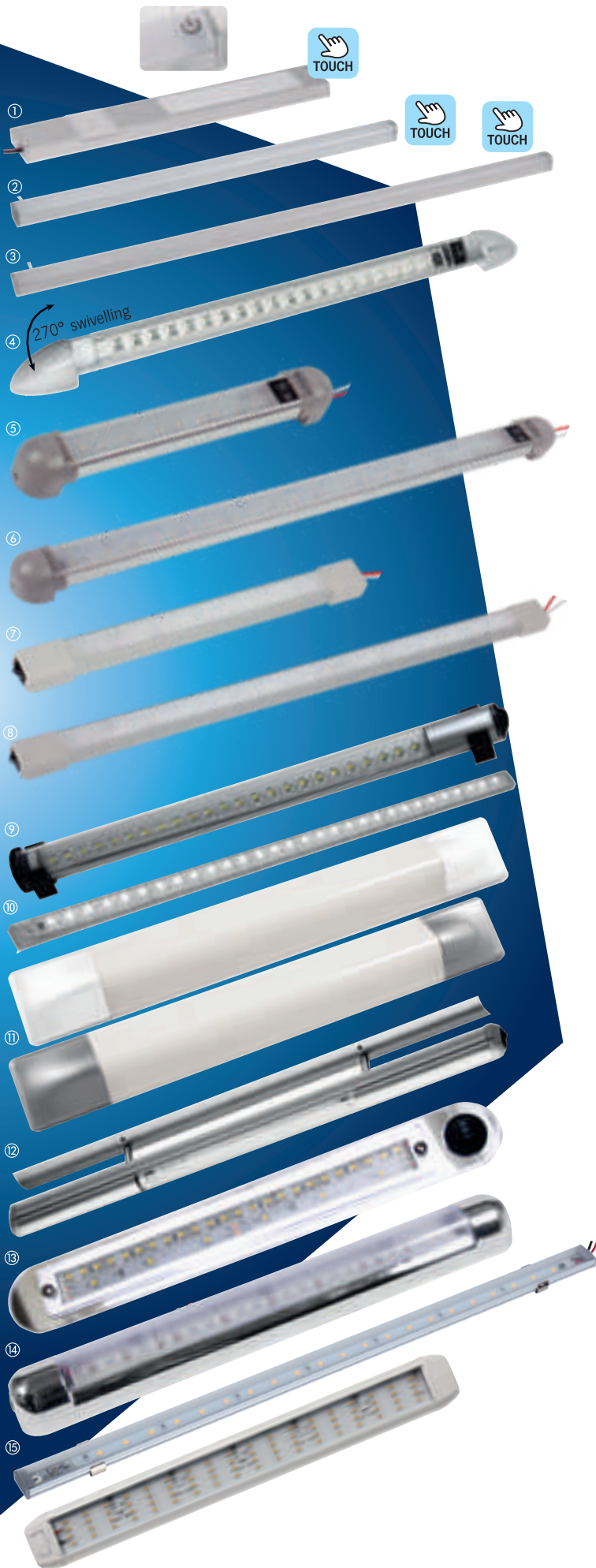

① **LED line luminaire 200 mm with touch switch** Stylish appearance due to aluminium housing. 12 V, 3.3 W, 18 LEDs, 185 lumen, 3,000 K, with touch switch. Hole spacing: 8 cm. Dimensions: L200 x W30 x H10 mm **83671 16,90**

② **LED line light 400 mm with touch switch** Elegant appearance due to aluminium housing. 12 V, 5 W, 27 LEDs, 360 lumen, 3,000 K, with touch switch. Length: 40 cm **83674 20,90**

③ **LED line light 600 mm with touch switch** Elegant appearance due to aluminium housing. 12 V, 7 W, 42 LEDs, 470 lumen, 3,000 K, with touch switch. Length: 60 cm **83675 28,-**

④ **LED line light Mini** Elegant appearance due to aluminium housing. 12V, 3.6 W, 18 LEDs, 126 lumen, 3,000 K, with on/off switch. Plastic end caps. Dimensions: L347x W16 x H21 mm. **835571 31,-**

⑤ **LED line light 225 mm** Stylish appearance due to aluminium housing. 12/24V, 2 W, 10 LEDs, 180 lumen, 3000 K, with on/off switch. IP65. Length: 225 mm. **83241 17,90**

⑥ **LED line light 470 mm** Elegant appearance due to aluminium housing. 12/24V, 6 W, 30 LEDs, 520 lumen, 3000 K, with on/off switch. IP65. Length: 470 mm **83242 37,90**

⑦ **LED line light 266 mm** Stylish appearance due to aluminium housing. 12/24V, 3.6 W, 18 LEDs, 340 lumen, 3000 K, with on/off switch. IP65. Length: 266 mm. **83243 18,90**

⑧ **LED line light 468 mm** Stylish appearance due to aluminium housing. 12/24V, 7.2 W, 36 LEDs, 570 lumen, 3000 K, with on/off switch. IP65. Length: 468 mm **83244 33,90**

⑨ **LED line light Ø 24 mm**, pleasant, warm, diffuse light With on/off switch. Can be rotated in the mounting clip. Length: 305 mm, 1.7 W / 10-14, 4 V **83385 34,90**
Length: 600 mm, 3.4 W / 10-14, 4 V **833851 59,-**

⑩ **LED strip module 500** 30 waterproof encapsulated high-power LED (protection class IP66), light output corresponds to 10 W halogen. Well suited, e.g. as indirect lighting, can simply be glued on or inserted into a groove. Dimensions approx. 522 x 18 x 11 mm, 10-15 V, 0.18 A. 2 W, temperature range -10-40° C. **83357 39,90**

⑪ **LED light Lava** with on/off switch, 12 V, 4 W, hole spacing: 25 cm
Housing colour white **83138 29,95**
Housing colour silver **83139 32,90**

⑫ **LED Alu Design Luminaire Stilo** Stylish light and design element in anodised aluminium for suspended or vertical mounting. End caps in grey ABS, glass in polycarbonate. Incl. holder. 12 volts. 668 x 40 x 46 mm, hole spacing: 22 cm **830281 67,90**

⑬ **Linear spot for diffuse light** with double switch. Night light 6 LEDs, normal light 24 LEDs, matt plexiglass shade, carrier plexiglass mirrored. 12 V, 0.3 W or 1.3 W. Dimensions: approx. 296 x 38 x 10 mm. Drill hole: Ø 20 x 20 mm. Height required for switch, hole spacing: 22 cm **833831 31,90**

⑭ **LED surface mounted light Linea** with switch, 3,6 Watt. Elegant 12 V light with 18 SMD-LEDs, 288 lumen. Chrome. In lined glass look, dimensions: 390 x 50 x 36 mm., hole spacing: 18 cm **835261 35,90**

⑮ **LED line light 5,0 Watt**, 400 Lumen, warm white (3000 K), beam angle 140°, lifetime 20.000 hours, dimensions: 403 x 17,52 x 6,87mm **830340 26,99**

⑯ **LED line light** with switch, 4 Watt, 432 Lumen, 72 LEDs
Dimensions: 368 x 45 x 10mm. **83992 42,90**



The energy label shown here is valid until 28.2.2021.

On 1.3.2021, in accordance with Regulation (EU) 2019/2016, the new EU energy label will be introduced, which is based on a new test procedure with a new Calculation formula.

Applies to all luminaires on this double page.

12V LED LIGHTS



12V
24V

LED surface-mounted luminaires

- elegant aluminium housing
- Frosted glass pane

Elegant appearance due to aluminium housing. 12/24V, with on/off switch. 3000K, IP65.

Length: 170mm , 18 LEDs, 3,6W, 310 Lumen	83245	16,90
Length: 370mm , 54 LEDs, 10,8W, 864 Lumen	83246	39,99



12V
24V

Fewer insects in the vehicle due to red light

NEW 2021

LED surface mounted luminaire Dual Colour

- Warm white light (3000K) for cosy ambient lighting
- Red light to avoid attracting insects
- Sturdy aluminium housing
- Easy mounting: screw or glue

The 12/24V Dual Colour LED light is equipped with 12 warm white SMD LEDs and additionally with 12 red SMD LEDs. Colour change via switch. Dimensions: 270 mm long, connection cable approx. 30 cm.

83589	36,90
--------------	--------------

LED aluminium light

① **LED aluminium line luminaire** 49 LEDs, 5 watts, 480 lumens. Luminaire can be positioned at an angle of 45° and 90°. Linking of several luminaires possible! Aluminium white, matt, with connection cable, length 300 mm.

83504	29,90
--------------	--------------

② **Main switch** **83498** **6,90**
 ③ **Connection box** **83499** **3,30**
 ④ **Connecting part** (for linking several luminaires) **83497** **1,30**
 ⑤ **Motion detector**
 can be set up at an angle of 0° to 90° **83500** **15,90**

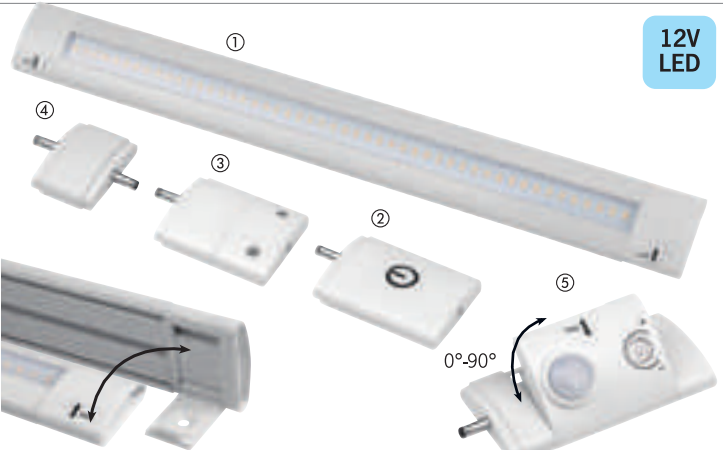

12V
LED



LED battery light with radio switch

- Ideal for the Reimo CampingBox
- Up to approx. 56 hours of light with only one set of batteries
- Radio switch with a range of up to approx. 35 metres (free area)

6 white LEDs, 55 lumen. Touch switch on the light. Additional radio switch (range approx. 35 m) for on and off. Can be mounted with screws or adhesive strips. Dimensions wireless switch: 85x85x20 mm, dimensions light: 300x50x20 mm. 3 x AAA battery for the switch and 4x AA battery for the light (not included). Mounting material included

83154	25,90
--------------	--------------



12V
LED

LED surface-mounted luminaires

- Extremely flat aluminium housing
- With diffusing lens for glare-free light
- W 90 x H 15 mm, available in 3 lengths

Aluminium with silver-grey plastic end caps. With embossed plastic glass. Length: 200 mm, 3 W, 288 lumen **83539** **36,90**
 Length: 300 mm, 6 W, 570 lumen **83546** **59,90**



12V
24V

LED awning lights

For panel van
12/24 V, colour: black, length: 231 mm, IP67, 3000 K, 4,5 W, 9 SMD LEDs, 530 lumen, ABS housing. **833771** **21,90**

For motorhomes
12/24 V, colour: white, length: 480 mm, IP67, 3000 K, 3,6 W, 18 SMD LEDs, 340 lumen, ABS housing. **83377** **27,90**



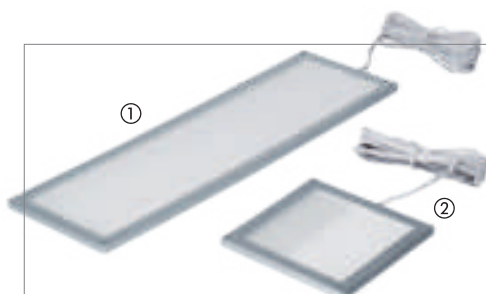

Super flat 12V LED panel

- Only 5 mm thick
- Dimmable, with 2m cable
- Warm white light with 3.000 K

① 6 W, dimensions: 100 x 200 mm	833691	34,-
② 3 W, dimensions: 100 x 100 mm	83369	21,90



LED surface area light

For wall and ceiling, made of plastic in white, 12 V, 5 Watt, 350 lm, 33 SMD LEDs. Colour temperature 3000 K, beam angle 180°. Dimensions: 70 x 70 x 14,5 mm

Dimensions: 130 x 130 x 14,5 mm	830341	17,95
	830342	27,-



LED lights with night light

- 36 warm white and 12 blue night light LEDs
- With touch switch

① Made of plastic, chrome and silver coloured. 12 V/5,5 W, 3,200 K, 550 lm, dimensions: Ø 129 mm, H 9 mm	83572	47,99
② Made of plastic, chrome and white. 12 V/5,5 W, 3,200 K, 550 lm, dimensions: 129 x 129 x 9 mm	83573	49,99

12V LED LIGHTS WITH BLUE NIGHT LIGHT



LED ceiling light with night light

- Very flat surface mounted light
- Operation via 3-way switch
- Plastic housing, silver
- Light white/blue switchable

2 light colours. 60 white LEDs, 12 V (900 lumen) or 12 blue LEDs as night light. Power: 12 W, dimensions: Ø 129 x H 9 mm.

835494	59,90
---------------	--------------



LED luminaire SlimLite

- Flat surface mounted light
- With push button switch (on/white/blue)
- Aluminium coloured plastic housing

Ceiling light with 2 switchable light colours. Either 84 white LEDs (234 lumen) or 12 blue LEDs as night light. Power 6,72 W. Dimensions: L 185 x W 111 x H 12 mm

835492	54,90
---------------	--------------



Round LED light Slim Down Light

- Touch switch
- Very flat plastic housing
- Light white/blue switchable

Slightly round ceiling light with 2 light colours. 36 white LEDs (588 lumen) or 6 blue LEDs as night light. Power 6 W. Dimensions: 129 x H 9 mm.

835490	49,99
---------------	--------------



LED lamp square

- With push button switch (on/white/blue)
- Elegant surface mounted housing

Ceiling light with 2 switchable light colours with 60 white LEDs (900 lumen) and 6 blue LEDs as night light. Power 7 W. Dimensions: L 177 x W 177 x H 20 mm.

835493	75,99
---------------	--------------



Round LED Light Mini Slim Down Light

- Touch Switch
- Light white/blue switchable

LED light Mini Slim Down Light 12 white LEDs (204 lm) & 6 blue LEDs as night light. Power 2.8W. IP66. Dimensions: Ø 69 x H 10 mm.

835491	19,99
---------------	--------------



LED wall and ceiling lights

- 3 x blue night light LEDs
- 18 white LEDs with 9 W
- 3-way switch

Consumption: 9/3 W, 12 Volt. Aluminium housing, plastic lens. Dimensions: 126 x 246 x H 37 mm.

83989	49,99
--------------	--------------



LED ceiling light

Ceiling light with 36 white LEDs and 12 blue night light LEDs. Silver with switch. Dimensions: 156 x 124 x 13,5 mm, 450 lumens, 7 watts.

83536	49,99
--------------	--------------



LED surface-mounted spotlight

- 6 x blue night light LEDs
- 12 white LEDs

2,4 W / 202 lumen, 84 x 10 mm, with switch.

83996	27,99
--------------	--------------

FLEXIBLE 12V LED LIGHTS



ON/OFF switch
in the luminaire head

Noble 12V reading lights with innovative on/off switch

Made of brushed nickel in two different lengths. Dimmable if additional dimmer is available. Ø 35 mm, 12 V, 1.2 W, warm white (3,000 K), 100 lm, beam angle 90°. Service life approx. 20,000 hours, total height: 160.5 mm
830343 35,90
 Total height: 300.5 mm
830344 39,90

203 mm

102 mm

Flexible LED spotlight

With 2 W LED, 110 lumen. Flexible arm, length 200 mm. With switch, colour black.

83394 29,90



Flexible LED spotlight

With 2 W LED, 110 lumen, Flexible arm, total length 300 mm. 3000 K

83398 21,90

12V LED CEILING & RECESSED SPOTLIGHTS



Ceiling light

Night-Wave, 6 white and 6 blue LEDs with switch, switchable blue night light. Ø 97 x H 30 mm. Plastic, silver, swivels. 2 W/120 lumen.

83529 25,99



Ceiling spot Wave

3 white LEDs with switch. Ø 105, H 24 mm. Plastic/metal, silver, swivels. 3 x 1 W/80 lumen.

83533 36,-



LED recessed luminaire

Recessed luminaire 9 SMD LEDs, 1.5 W, 144 lumen, light colour 3200 K (warm white), Ø 72 mm, H 25 mm, mounting height 6 mm. Hole drilling for installation Ø 52mm. Housing colour: silver. With spring clips

833191 18,99

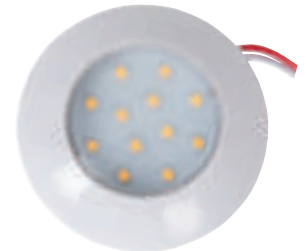

12/24 V LED spotlight

Colour: white, 3000 K, 2.4 W, 12 SMD LEDs, 240 lumen, ABS housing Dimensions: Ø 75x18 mm. IP67

83373 9,99

FANCY 12V LED SPOTS



LED spotlight with touch switch and glass shade

12 V, incl. night light function, material: brushed nickel, 3000 K, 2 W, 1x COB LED, 180 lumen, dimmable via touch switch, weight: approx. 230 g.

83187 18,99



LED spotlight with touch switch and lampshade in white

12 V, incl. night light function, elegant lampshade in white, material: chrome, 3000 K, 2 W, 1x COB LED, 80 lumen, dimmable via touch switch, Weight: approx. 170g.

83188 27,99



LED spotlight with touch switch and USB port in base

12 V, incl. night light function, glass shade, material: brushed nickel, 3000 K, 2 W, 1x COB LED, 180 lumen, dimmable via touch switch, weight: approx. 190g.

83189 29,90



Applies to all luminaires on this double page.

The energy label shown here is valid until 28.2.2021.

On 1.3.2021, the new EU energy label will be introduced in accordance with Regulation (EU) 2019/2016, which is based on a new test procedure with a new calculation formula.

Mini LED Spot

12V, material: metal, 3000K, 2W, 1x COB LED, 110 lumen. Length of connection cable: 90 cm Mounting screws. Dimensions: LxWxH 5x1,8x5,8 cm.

83399 17,90



12V SMD LED TECHNOLOGY

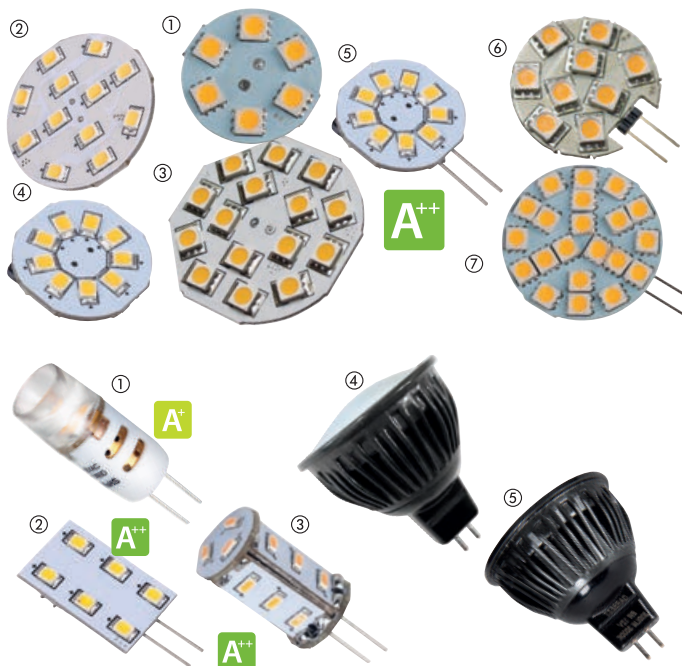

Flat boards S, M, L - angle 120°, socket G4

Pins rear

- ① Type S, 6 x SMD, 1.5 Watt, 120 lm, Ø 26 x 8 mm **830323 5,90**
- ② Type M, 12 x SMD, 2 Watt, 170 lm, Ø 30 x 8 mm **830324 5,90**
- ③ Type L, 15 x SMD, 3 Watt, 200 lm, Ø 35 x 8 mm **830325 5,90**
- ④ type S, 9 x SMD, 1.5 Watt, 120 lm, Ø 25 x 8 mm **830326 5,90**

Pins sideways

- ⑤ type S, 9 x SMD, 1.5 Watt, 120 lm, Ø 25 x 8 mm **830326 5,90**
- ⑥ Type M, 9 x SMD, 1.5 Watt, 150 lm, Ø 27 x 8 mm **830327 6,90**
- ⑦ Type L, 2 x SMD, 3.0 Watt, 270 lm, Ø 35 x 8 mm **830328 6,90**

Pin-base LEDs

- ① 4 x SMD, 1.5 Watt, 60 lm, angle 120°, socket G4, Ø 11,2 x H 23,5 mm. **830320 5,50**
- ② 6 x SMD, 1.2 Watt, 90 lm, angle 120°, W 18 x H 27,5 mm, base G4 **830321 5,90**
- ③ 15 x SMD, 1 Watt, 82 lm, angle 300°, Ø 12 x H 22 mm, base G4 **830322 4,90**

LED cold mirror

- ④ **MR 11** - 9 x SMD, 1.5 Watt, 120 lm, aluminium, angle 120°, Ø 34,5 x H 39 mm, base GU4 **830336 7,50**
- ⑤ **MR 16** - 4 x SMD, 5 Watt, 240 lm, aluminium, angle 120°, Ø 50 x H 54 mm, base GU5.3 **830337 8,90**

12V COB LED TECHNOLOGY OF THE LATEST GENERATION

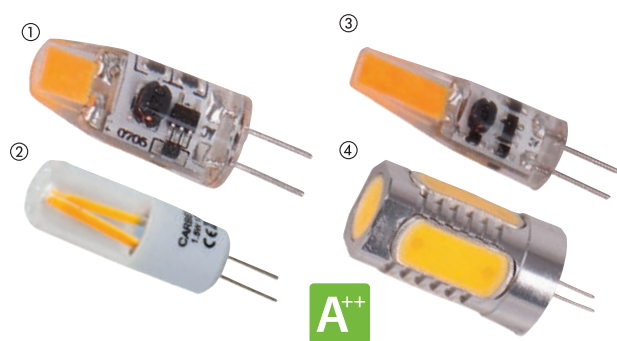

G4 COB bulb

- Base G4
- Light colour 3000 Kelvin

- ① 1 x COB-LED, 12 V, silicon, 90-100 lm, not dimmable, IP20, angle 220°, dimensions: Ø10 x 22 mm. **1,5 Watt 830329 6,95**
- ② 2 x COB-LED, 12 V, 120 lm, not dimmable, IP20, angle 360°, dimensions: 10 x 40 mm. **1,5 Watt 830330 5,95**

- ③ 1 x COB-LED, 12 V, silicone, 200 lm, not dimmable, IP20, angle 360°, Ø 10 x 30 mm. **2 Watt 830331 8,90**
- ④ 5 x COB-LED, 12 V, COB light source, aluminium, 400 lm, not dimmable, IP20, angle 120°, dimensions: W 15.3 x H 33 mm. **5 Watt 830332 8,90**

The energy labels shown here are valid until 28.2.2021

On 1.3.2021, the new EU energy label will be introduced in accordance with Regulation (EU) 2019/2016, which is based on a new test procedure with a new calculation formula.

OUTDOOR LIGHTS

- All lights with integrated rechargeable battery via USB
- All lights for standing or hanging in tents
- Cold white light



① Large light with mosquito protection

2000 mAh rechargeable battery, 3.2 W 16 SMD LEDs, integrated mosquito protection light and power bank function. 4-stage switching: 100% light output / 50% light output / signal flashing / off. Dimensions: Ø 98 x height: 135/190 mm **930614 24,90**

② Foldable light with mosquito protection

1000 mAh battery, 2 W 4 SMD LEDs, integrated mosquito protection light. Compactly foldable, 4-stage switching: 20% light output / 50% light output / 100% light output / off. Dimensions: Ø 94 x 52 mm **930615 16,99**

③ Battery camping light with mosquito protection

2000 mAh rechargeable battery, 1 W, integrated mosquito protection light. With charging indicator. 4-stage switch: 20% light output / 50% light output / 100% light output / off. Dimensions: Ø 88 x 129 mm **83494 24,99**

④ Small globe light

1000 mAh rechargeable battery, 1.5 W 3 SMD LEDs, light duration max. 14 hours 4-stage switching: 100% light output / 50% light output, 20% light output / off Light output / off. IPX7, dimensions: Ø 80 x 102 mm **930613 11,90**

STRONG LED/COB LED LUMINAIRES

LED Torch Lights

- LED light with atmospheric, realistic flame effect
- Rechargeable via Micro-USB

① LED table light with integrated Bluetooth speaker

Uncomplicated pairing with the smartphone. Transmission range >10 m. Volume >90 dB. Power supply: 5 V 1 A
Output power: 5 W, 2000 mAh Li-polymer battery. Material: ABS.
Dimensions: Ø 98 x H165 mm **83184 27,99**

② LED stick torch with flame effect

Authentic flame effect with 96 LEDs, 2 W, 100-200 lumens. Integrated 2200 mAh rechargeable battery. Rechargeable via solar panel in the lid or via Micro-USB cable. Dimensions: Ø 95 mm, with 4 rod elements, max. height 830 mm **83588 24,99**

③ Solar Light Chain

- Atmospheric party light chain with 10 LED lanterns

With solar panel (2 V, 10 mA) and rechargeable batteries. Burns for approx. 8 hours, cable length 4 metres. **83183 8,99**



Rechargeable COB multifunctional spotlight

4.000 mAh battery 15W, robust aluminium housing and adjustable stand. Lumen: approx. 800 lumen (level 1), approx. 450 lumen (level 2), Scope of delivery: Spotlight with stand, 12V + 230 V charging cable, Charging time: approx. 6h, Battery life: approx. 1.5 h (level 1), 5 h (level 2)

83492 49,95



COB pocket and workshop light

Very bright COB light for a wide variety of uses. Very strong magnets on the back. Can be adhered to metal surfaces. Bracket can be rotated 360°. With snap hook. 150 lumens.

3 x AAA battery (not included).

83488 7,90



COB clamp light

3 W COB + 1 SMD LED, 120 lumens + 30, lumens, 3 x AAA batteries (not included), 2 strong magnets on the back, clamp function, with joint for optimum adjustment possibilities

83490 9,90



① Solar/230V/12V camping light

Rechargeable LED camping light with integrated solar panel in the lid. Charging via solar, 230 V or 12 V adapter. With USB port 5 V / 1 A for charging mobile phone & Co, 500 lumen. 4.000 mAh battery for very long lighting time. 3 light settings: very bright (approx. 4 h) and flashing mode (approx. 8 h). With silicone protection cap over the connections. Dimensions: D: 82 x W: 82 x H: 82 mm

834871 44,99

② **Battery camping light** Powerful 3 W COB camping light (500 lumen), battery operation (3 x D battery not included), dimensions: 82 x 82 x 182 mm, weight: approx. 394 g, battery life: approx. 4 h **834872 26,99**

③ COB multi-function penlight

Battery operated (3 x AAA). Clip, ultra-bright LED, with loop

83528 7,99



STYLE ALUMINIUM PROFILES FOR ALL LED-FLEX TAPES WITH 10mm WIDTH

- Individual luminaire construction for atmospheric lighting
- Suitable for Carbest LED flex strips with 10 mm width
- Profile length: 1.5 m
- Perfect combination with furniture panels and furniture parts

The aluminium profiles are a professional solution for laying LED strips. With the profiles and the LED strips on page 39, you can easily create your own lighting. The profiles are also ideal for use in furniture construction, e.g. to conceal or stylishly illuminate the overhang of different wooden panels. This creates effective lighting accents that can be perfectly integrated into the furniture. In this way, corners and areas under cabinets and shelves are illuminated in a targeted manner. For the light diffusion you have the choice between the semi-transparent, satin cover or the, white appearing, opal version. Each set comes with 2 end caps, which you can extend with further end caps. Bandwidth: 10 mm

All aluminium profiles are supplied WITHOUT LED flex strips.

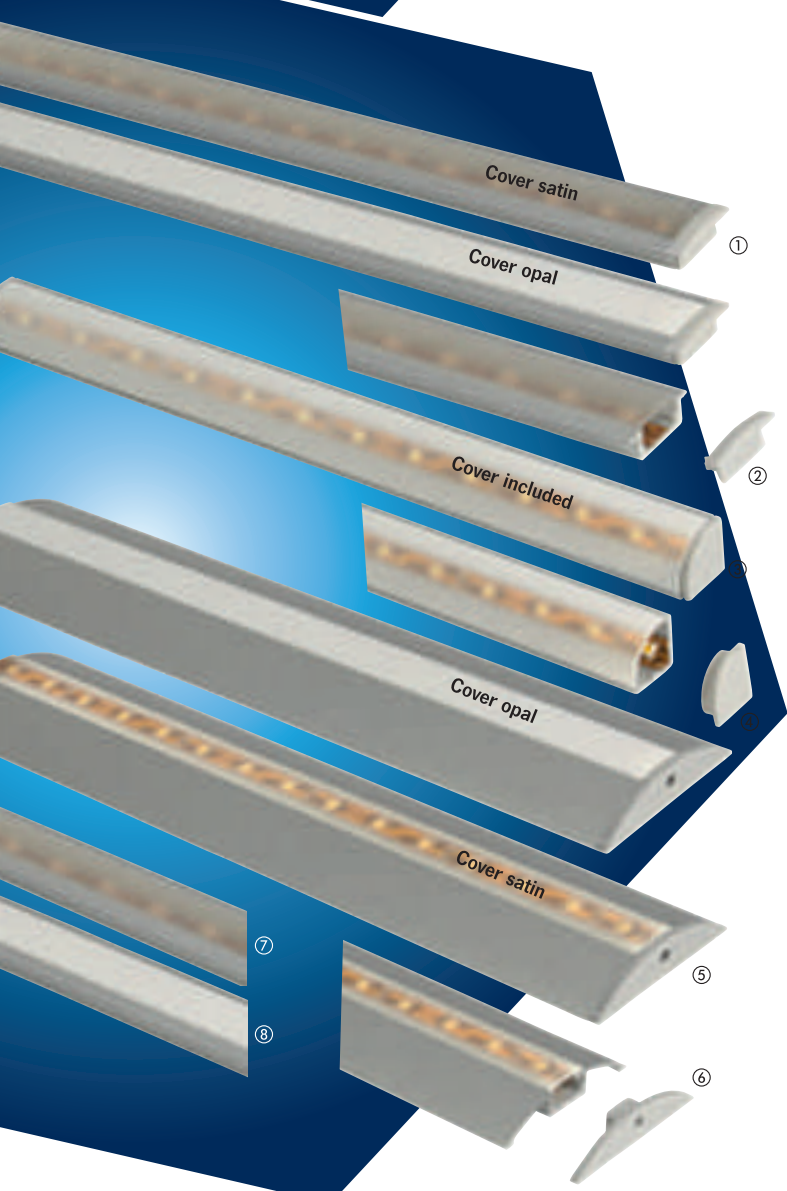

① Set aluminium profile flat, including 2 end caps. For mounting or recessing in a groove. Length: 1,5 m	82999	9,99
② End caps (2 pieces) for 82999	82980	0,70
③ Set of angled aluminium profiles, including cover and 2 end caps. For mounting in corners and under cabinets. Length: 1.5 m	829991	15,99
④ End caps (2 pieces) for 829991	82981	1,99
Fixing clips (2 pieces) for 829991 (not shown)	829810	1,99
⑤ Set of aluminium profile, half-round, including 2 end caps. For screwing on and covering at transitions of e.g. furniture panels. Length: 1,5 m	829992	15,99
⑥ End caps (2 pieces) for 829992	82982	1,99
⑦ Cover for 82999 / 829992 satin (semi-transparent) Length: 1.5 m	82983	6,99
⑧ Cover for 82999 / 829992 opal (white). Length: 1.5 m	82984	6,99

PROFESSIONAL LED-FLEX TAPES WITH WARM WHITE LIGHT

12 V LED flex ribbon Topview for indoor & outdoor use
30 LEDs/m, 2.4 W/m, 187 Lumen/m, 3,000 K, IP66, warm white, 5 m roll, strip width: 8 mm **83174 22,90**

12 V LED flex strip Topview for indoor & outdoor use
60LEDs/m, 4,8 W/m, 390 Lumen/m, 3,000 K, IP67, warm white, 5 m roll, tape width: 5 mm

83171 39,90

12 V LED flex tape Topview for indoor & outdoor use
120 LEDs/m, 9,6 W/m, 780 Lumen/m, 3,000 K, IP67, ideal as awning lighting, incl. 1 m connection cable (waterproof), warm white, 5 m roll, Strip width: 10 mm

83170 64,90

12 V LED flex strip Topview for indoor use
60 LEDs/m, 4,8 W/m, 390 lumen/m, 3,000 K, IP20, warm white, 5 m roll, strip width: 5 mm **83172 34,90**

- Atmospheric lighting indoors / outdoors
- All LED flex strips are dimmable
- Self-adhesive back - Can be shortened after every 3rd LED



12V LED

Fig. shows Flexband Topview



LED-FLEX TAPES WITH RGB OR BLUE LIGHT

- All LED flex strips are dimmable
- Self-adhesive, can be shortened after every 3rd or 6th LED

12 V LED flex ribbon RGB and warm white in one 72 LEDs/m, can be shortened after every 6th LED, 10 W/m (all LEDs), 4.5 W/m (warm white LEDs), 35 lumen/m (warm white LEDs), warm white 3,000 K, IP65, 5 m roll, strip width: 10 mm **83175 69,90**

① **RGBW control unit with remote control**

Specially designed for RGBW LED flex strip 83175
Light effects and light colour. **83179 22,90**

② **RGB control unit with remote control**

Especially for RGB LED-Flexband 831008. For controlling light effects and light colour. **831009 11,99**

12 V LED flex ribbon blue for indoor & outdoor use
60 LEDs/m, 4,8W/m, 40-45 Lumen/m, IP68, 5 m roll, tape width: 8 mm, including 10 mounting clips and 20 end caps **831007 49,99**



(83175)



(831007)



①

RGBW control unit & Remote Control (83179)



②

RGB control unit & Remote Control (831009)

12V LED

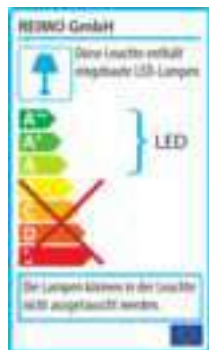

The energy label shown here is valid until 28.2.2021
As of 1.3.2021, in accordance with the Regulation (EU) 2019/2016 the eU energy label will be introduced, a new test procedure with a new calculation formula Basis.



12 V dimmer with remote control

For single color LED strips or dimmable luminaires. Functions: Brighter/ Darker, On/Off. Ideal for retrofitting awning lights as there is no need to fit an additional switch. Max up to 96 Watt, quiescent current approx. 30 mA. Dimensions: L 90 x W 60 x H 37 mm.

831003 19,99

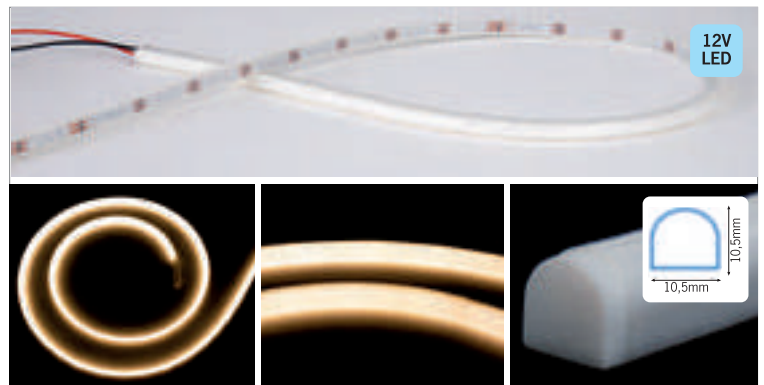

12V LED

10,5mm
10,5mm

Flexible LED light tube for indoor & outdoor use

Length of light tube: 5m, width and height: 10,5mm, 10,8W, 150 LEDs/m, 620 lumens, 3000K. Dimmable and can be shortened. IP67.

83178 84,90

End cap set for LED light scarf 83178, consisting of 2 pieces

831781 2,50

RELIABLE GAS DETECTORS

GasCube - Gas detector in noble design, now in a new improved version

- Warns of propane/butane gas (LPG) and narcotic gases
- Visual and audible indication of readiness for operation, the calibration phase and the alarm
- Blue light = ready for operation / Red light = alarm!

Fixed connection to 12 V on-board power supply. Pressure switch. Ready for operation after approx. 3 minutes. With highly sensitive sensor and 80 dB loud siren. Temperature-controlled sensor, which also works reliably above 25°C. Power consumption in standby: 100 mA, power consumption in alarm: 180 mA. Mounting: approx. 100 cm above the ground. Dimensions: 55,6 x 86,7 x 24 mm.

- ① **GasCube** Colour: matt white **802482 64,90**
- ② **Counter display** with 10x GasCube matt-white **802480 632,64**

③ **Gas CubePlus with additional external gas sensor:**
Features identical to above GasCube but with external gas sensor. The additional sensor detects the gas concentration in the air just as effectively as the main sensor and provides additional safety in the event of rising and falling gases. The main sensor should be installed about 100 cm above the floor, the smaller external sensor about 30 cm above the floor. Cable length is 2.7 m. This allows liquid gases (LPG/narcotic gases) to be detected even more efficiently. Colour: Gloss anthracite

80249 99,90

④ **NEW: GasCubeTwin** Equipment identical to above mentioned GasCube, but with connection possibilities for two optional additional sensors. These detect the gas concentration in the air just as effectively as the main sensor and provide additional safety in case of rising and falling gases. Cable length is 2.7 m.

There are 3 possible combinations of the additional sensors

- 1.2x sensor for detection of CO gas (carbon monoxide)
- 2.2x sensor for detection of LPG gas/narcotic gas
- 3.1x sensor CO gas + 1x sensor LPG gas/narcotic gas

GasCubeTwin Colour: Matt anthracite **802483 69,90**

⑤ **Additional sensor CO gas (carbon monoxide)** **802484 29,90**

⑥ **Additional sensor propane/butane gas (LPG)** **802485 29,90**

⑦ LPG gas detector at a TOP price

Warns reliably of gas leaks, acoustic alarm 85 dB, mounting height for butane/propane gas detection approx. 20 to 40 cm above the ground, 12 Volt, current consumption 100 mA. Temperature range -10/+50°C. Dimensions 115 x 70 x 60 mm. Scope of delivery: LPG gas detector, mounting material **80216 29,99**

⑧ 2 in 1 combi gas detector

- Detects various fuel gases, natural gas, LPG and carbon monoxide
- 2 integrated sensors
- Self-test function, acoustic and optical alarm
- Suitable for wall mounting

Operating voltage: DC 12 Volt, temperature range: 0°C ~ +50°C
Alarm sound signal: 85 dB/3 m, LPG gas alarm: sound continuous
Dimensions: 118.5 x 82 x 43 mm **80218 36,90**

VALUE

① Safety - Transportable safety cassette

Safety can be quickly inserted or removed at any time thanks to the firmly screwed holder supplied. The cassette is firmly connected to the holder by means of a lock. Dimensions: holder approx. W16 x D22 x H7 cm, cassette approx. W15 x D21.5 x H6 cm. Weight: 1,7 kg. Scope of delivery: safebox, holder, 2 keys, 6 screws.

47132 24,99

② Rex - Versatile furniture safe

Whether installed in a cupboard or bookcase, used in a caravan, motor-home, yacht or office, Rex keeps your belongings under lock and key. Weight: 6.8 kg. External dimensions: approx. W31 x D20 x H20 cm. Scope of delivery: safe, 2 keys, fixing material **47136 49,90**



CEE PLUGS AND CABLES FOR PROFESSIONAL USE



CEE angled plug
For a kink-free connection to the power column or socket.
820302 5,99



CEE coupling
Suitable for connection to CEE input sockets.
82032 4,50



CEE plug
Suitable for CEE socket on campsites and CEE couplings
82031 4,40



Adapter CEE/Schuko
CEE coupling with cover
82007 9,50



CEE angle coupling
CEE 17 European coupling with integrated shock-proof socket and hinged cover, suitable for CEE input sockets.
82030 6,99



Plug Switzerland
to CEE coupling, 10 A, H=7RN-F
Cable 3 x 2.5 mm².
0,4 m 821541 21,50
1,5 m 821544 24,90



CEE plug
to coupling Switzerland, H=7RN-F
cable 3 x 2.5 mm².
0,4 m 821542 23,99
1,5 m 821545 14,49



Plug GB
to CEE coupling, H=7RN-F cable 3 x 2.5 mm². Approx. 20 A.
0,4 m 821543 7,65
1,5 m 821546 8,50



2-fold distributor
CEE plug/2-way CEE distribution socket with hinged cover
82301 13,99



Adapter Schuko/CEE
CEE-plug/CEE-coupling with cover.
82044 16,-



CEE surface-mounted power socket
Ideal for concealed installation in the engine compartment (e.g. on T5) with cover 3-pole 230 V / 16 A.
82008 13,90



CEE socket
for fixed mounting. With hinged cover, plastic. For current collection on campsites, in garages, Carportsetc.
82091 8,79



CEE Safebox
For protection against moisture. With lock, L 365 mm, Ø 100 mm
820432 9,70



Adapter Schuko/angle
Schuko plug/CEE angle coupling with additional Schuko socket. Prevents kinking of the cable. H07 RN-F 3 x 2.5 mm².
1,5 m 82020 15,50
25 m 820201 69,99
H07 RN-F 3 x 1,5 mm² (only for export) 82025 12,99



Adapter CEE/Schuko
CEE plug/chuko rubber coupling H07RN-F 3 x 2.5 mm² incl Carrying bag
1,5 m 82022 9,90
0,4 m 820221 8,90
H07 RN-F 3 x 1.5 mm², 0,4 m (only for export) 820261 7,99



Adapter Schuko/CEE
Schuko plug/CEE coupling, H07RN-F 3 x 2.5 mm², incl. carrying bag
0,4 m* 820211 12,99
1,5 m* 82021 15,-
4,0 m* 820212 19,99
25 m* 820213 59,90
5H07 RN-F 3 x 1,5 mm² (only for export) 0,4 m 8202110 7,75
*also suitable for France

Cables with 3 x 1.5 mm² are not approved for outdoor use in Germany!

PROFI CEE CABLE DRUM FOR MANY APPLICATIONS



① **CEE cable drum** 3-pole CEE plug (on the drum) and CEE coupling (on the short end). Campsite approval up to 25 m. 16 A, H07 RN-F 3 x 2.5 mm².

25 m **820481** **77,99**

② **CEE cable drum** H07 RN-F 3 x 2.5 mm². 2 Schuko/ 1 CEE socket, thermal protection switch.

25 m **82027** **94,90**

③ **CEE cable drum** 3-pole CEE plug (on the drum) and CEE angle coupling and Schuko coupling (on the short end). Campsite approval up to 25 m. 16 A, H07 RN-F 3 x 2.5 mm².

25 m **820483** **84,99**

Our accessory tip:
 cable transport bag **820292**
 Cable tie with handle **820091**
 Hand cable drum **82009**



CEE extension cable

Neoprene rubber cable. Incl. transport bag. Suitable for outdoor use. Incl. carrying bag

H07RN-F, 3 x 2.5 mm ²		
10 m	82018	32,90
25 m	820181	57,90
H07RN-F, 3 x 1.5 mm ² (only for export)		
10 m	82024	24,90
25 m	820242	51,99
40 m (without bag)	820244	69,90



CEE plug/angle coupling

With additional Schuko socket. 3 x 2.5 mm²

1,5 m	82036	19,99
15 m	820362	49,99
25 m	820361	69,99

With additional Schuko socket 3 x 1.5 mm² (only for export)

20 m	82204	39,99
30 m	822041	44,90



CEE connection cable

CEE plug/coupling, 3 x 2.5 mm², length: 1.5 m

	82035	14,99
--	--------------	--------------



3-fold socket strip

With three Schuko sockets and cover caps, 10 m connection cable + CEE plug, automatic circuit breaker fused with 25 A. In plastic housing with suspension device

2 clamps Ø 21 mm for clipping to clip onto tent poles		
3 x 1,5 mm ² (only for export)		
10 m	82210	59,99



3-fold socket strip

With three Schuko sockets and cover caps, 10 m connection cable with CEE plug. Plastic housing. H07 RN-F 3 x 2.5 mm².

10 m	82208	34,90
As 82208 but with 3 x 1,5 mm ² (only for export)		
1,5 m	82209	17,99
5 m	822091	17,96

Cables with 3 x 1.5 mm² are not approved for outdoor use in Germany!

PROFI SCHUKO ACCESSORIES FOR 230 VOLT



Plug / Coupling

- ① Schuko rubber plug SB-Pack.
82033 2,99
- ② Schuko rubber coupling
SB-Pack. 82034 4,30



Schuko distributor

- Extension distributor Schuko/
Schuko
Schuko plug to double Schuko
socket. With 1,5 m cable and 2 cov-
ers. H07 RN-F 3 x 2,5 mm².
82006 7,95



Cable drum with 4 sockets

- Rubber cable with Schuko plug and 4
Schuko sockets with cover. For indoor
use. SB pack, splash-proof. H05 RR-F
3 x 1,5 mm² (for export only)
25 m 820451 44,90



Cable drum with 4 sockets

- Rubber cable with Schuko plug and 4
Schuko sockets with cover. For indoor
use. SB pack, splash-proof. H05 RR-F
3 x 1,5 mm² (for export only)
7,5 m 82153 17,99



Power strip

- Schuko plug to Schuko socket strip
with hinged covers. For indoor use.
With 2,5 m cable, H05 RR-F 3 x 1,5
mm².
5-way 82151 12,90
4-fold 82152 13,99



Schuko distributor plug

- ① 2-fold socket with cover flaps
82201 5,99
- ② 3-fold socket outlet with 1,5m
cable With cover flaps.
H07 RN-F 3 x 2,5 mm²
82202 10,99



Schuko safebox

- for protection against moisture. Box
without lock, L 210 x Ø 70 mm.
820431 3,99



Schuko adapter including USB

- Schuko socket adapter with 2 x USB
charging ports Input: AC85-265 V
50/60 Hz, Output: DC5V-2,1 A (max.)
82302 7,99



Hand cable reel

- for rolling up the extension cable of max.
35 m, cable 2,5 mm²
82009 9,99



Cable transport bag

- Convenient transport of cables. Suit-
able e.g. for hand cable drum (art.
no.: 82009). Size: Ø 40 cm,
Width: 14 cm.
820292 9,99



Cable tie with handle

- for bundling, carrying and stowing. Can
be used again and again. Suitable e.g.
for 25 m cable (H07 RN-F 3G 2.5) or for
40 m cable (H07 RN-F 3G 1.5)
820091 4,99



Cables with 3 x 1.5 mm² are not approved for outdoor use in Germany!

TRAILER ELECTRICS



Mini short adapter

From 13 to 7 poles. Very compact version for cars with 13-pole socket and trailers with 7-pin plug.

82137 9,99



Plug 7-pole

• Plastic housing
On towing vehicle.

82100 3,80



Plug 7-pole

• Steel housing

82132 3,80



Plug 13-pin

• With locking device.
Contacts nickel-plated

82106 8,99



Short adapter

From 7-pin or Multicon socket on towing vehicle to 13-pin plug on trailer.

82107 9,99



Trailer socket

• 7-pin
• Steel housing

821321 4,95



Trailer socket

• 7-pin
• Plastic housing

821022 3,99



Trailer socket

• 13-pin
With switch-off of the rear fog light on the car

82105 8,99



Coupling

• 7-pole
For extension cable with 7 connection poles

82101 6,99



Coupling

• 13-pole
For extension cable with 13 connection poles

82113 9,49



Short adapter

From 13-pole socket on the towing vehicle to 7-pole Plug on the trailer.

82108 7,49



Adapter cable

• Socket to plug
• Cable 30cm long:
7-pin socket to 13-pin plug
7-pin socket to 7-pin plug

821324 13,49
821325 4,99



Assignment of 7- and 13-pin connectors

13-pin 12 V plug system for cars and trailers.

Vehicles with a towing device are equipped with a 13-pin socket equipped. Rear fog light has been mandatory for trailers since 1.1.1991. The last free pole of the previous 7-pin plug connection is occupied. (Continuous current in the vehicle is no longer possible).

Additional connection possibilities of the 13-pin plug connection: reversing light, continuous current for caravan, charging line for an additional battery or for light in the trailer, etc.

Adaptations: allow any combination between 7- and 13-pin vehicles and trailers. The attachment points are identical for 7- and 13-pin plugs.

Safe in function due to:

High-quality contacts with surface finish, Bayonet locking, Long service life as temperature resistant from +100° to -40°C. Dust and waterproof.

*The 13-pin Multicon world plug (WeSt) also fits into 7-pin junction boxes, but not in today's 13-pin sockets (Jäger system)

Standard 7-pin



Standard 13-pin (Hunter system)



13-pin Multicon (WeSt)



no longer usual

7-pin | 13-pin

No.	DIN	No.	DIN	Consumer	Color	Cable Ø
1	L	1	L	Turn signal left	yellow	1,5
2	54G	2	54G	Fog-locking l.	blue	1,5
3*	31	3*	31	Ground (7 pin) Ground 1-8 (13 pin)	white	2,5
4	R	4	R	Turn signal right	green	1,5
5	58R	5	58R	Taillight re.	brown	1,5
6	54	6	54	Brake light	red	1,5
7	58L	7	58L	Taillight li.	black	1,5
		8	ZR	Reversing light	grey	1,5
		9	30	Continuous positive (+)	brown/blue	2,5
		10		Charging line (+)	brown/red	2,5
		11		unallocated		1,5
		12		unallocated		1,5
		13*	31	Ground Pole 9-12	black/white	2,5

*The ground lines must not be connected conductively.

CARAMOVE II

CARAVAN MANOEUVRING SYSTEMS

7 years
Parts warranty

NEW
2021

Cara-Move II Automatic

- Automatic engagement drive
- Move the caravan effortlessly up to 2250 kg
- Lightweight due to plastic cover
- Easy and stress-free manoeuvring with the Smart Handset
- Suitable for single and double axle caravans
- 7 year parts warranty

Move your caravan effortlessly up to 2250 kg with the automatic manoeuvring system. The Smart remote control makes manoeuvring easy and stress-free. Suitable for single and double axle caravans.

Smart Handset & Control System

Simple and intuitive operation. Precise manoeuvring thanks to the unique roller-ball design. Variable speed control and 360° fluid movement, so you really have effortless control of your caravan. Speed: 12 cm/sec, Operating voltage: 12 V DC Weight (2 motors): 23 kg, Combined weight (incl. installation kit etc.): approx. 34 kg, Max. Climbing capacity according to total weight:

15% - 2500 kg / 20% - 2250 kg / 25% - 2000 kg

Scope of delivery: 2 motors, mounting bracket, remote control, battery disconnect switch (100 A), rocker arm, mounting material, operating instructions

920209 1399,-

Cara-Move Manual

- Sturdy aluminium drive rollers
- Soft-start precision control
- Compact, stable, reliable
- Convenient remote control
- 7-year parts warranty

The manual caravan manoeuvring aid moves single and double axes up to a maximum total weight of 2250 kg. The rollers are swivelled on and off manually is done manually. Power consumption on level ground: approx. 25 A, Max. Current consumption (1100 kg caravan single axle, gradient 25%): 80 A, Weight: 35 kg Max. Climbing capacity according to total weight:

15% - 2500 kg / 20% - 2250 kg / 25% - 2000 kg

Scope of delivery: 2 motors, mounting bracket, remote control, battery disconnect switch (100 A), rocker arm, mounting material, operating instructions

920208 949,-

AUTOLIFT - FULLY AUTOMATIC LIFTING SUPPORTS FOR VEHICLES UP TO 5 TONS

- **Reliable:** With waterproof motors and connections
- **12V power supply, emergency operation in case of power failure**
- **Convenience:** Operation via the panel in the cockpit or via remote control
- **Levelling takes place independently and fully automatically**

Technical data:

Load capacity per support 2000 kg, total support load 5000 kg, support base length 300 mm - can be extended up to 420 mm, ground clearance must be guaranteed. Consumption in operation approx. 12A.

Autolift with 2 lifting supports	465101	1539,-
Autolift with 4 lifting supports	465100	2439,-
Adapter set for Fiat Ducato X250/290	465102	250,-
Adapter kit for Fiat Ducato X250/290 Alko	465103	150,-
Adapter kit for Fiat Ducato X244	465104	250,-
Adapter kit for Fiat Ducato X244 Alko	465105	250,-
Adapter kit for Ford Euro 4	465106	250,-
Adaptor kit for Ford Euro 6	465107	250,-
Adapter kit for Iveco Daily	465108	250,-
Adapter set for Renault Master	465109	250,-
Adapter set for Mercedes Sprinter	465110	250,-
Universal clamps	465111	143,-

7 years
Parts warranty

NEW
2021



Operating element and remote control of the Autolift with 4 lifting supports

PRACTICAL ACCESSORIES



SET



Shims with handle

for height compensation, as base for trestles or support feet, 4 pieces, load capacity: 2,5 tons per set, material: PP (plastic), dimensions: 225 x 165 x 22 mm, weight/plate approx. 220 g,

91186 14,99



SET



Universal shims

- 4 plates for height compensation
- Anchor model to snap in

For height compensation under trestles or support feet. Dimensions: 21 x 21 x 3,3 cm, weight per plate 310 g 4 pieces

91187 14,99



SET

Aluminium trestle set, 4 pieces

- Height adjustable from 28,5 - 42 cm
- 1000 kg load capacity per piece
- Stackable with metal spindle

WxH: approx. 16 x 23 cm. Weight 3,2 kg

912061 47,99

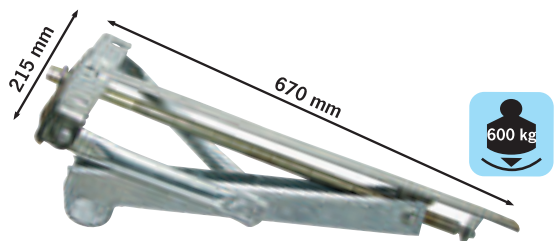

Galvanized universal crank support

- Static load capacity 600 kg per support Extension length: 497 mm, weight: 3.5 kg

912323 35,99



Caravan clip-on mirror

- Variable gripper arm
 - E-mark available
- Mirror glass: L: 15 x H: 11 cm Projection: 35.7 cm, Weight :284 g

473002 19,90



Reserved sign for setting up. For motorhomes and caravans. Dimensions: 61.5 x 30 cm

47085 11,99



SET

Step wedge XL

2x Multi-level ramps/step wedges are ideal for levelling caravans or motorhomes on uneven ground. Ramp size: 61x21.5x12 cm, Material: PP 2150 g, Loading capacity: 5 t

Set of 2, colour: grey

912554 23,99

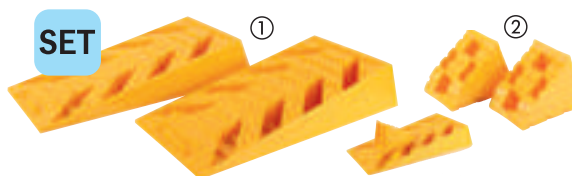

SET

Set of 2 ramp wedges and optional blocking wedges

- ① Made of HDPE plastic, load capacity: 5 t, dimensions: L 43 x W 19 x H 9 mm. Set of 2 Colour: Yellow 93125 14,90
- ② Matching blocking wedges, dimensions: 13 x 8.5 x 9 cm. Set of 2 Colour: Yellow 93126 5,95



SET

Support plates set of 4

Plastic support plates in yellow, set of 4 for crank supports, with metal pin. Can be excellently combined with caravan pads 911951.

91195 9,95



①

②



① Support load scale aluminium

Plastic base. Weighing range 50 to 100 kg. 912250 15,45

② Digital load scale

Digital, easy to read display. Continuous reading during loading. Remains accurate even after long use. Measuring range up to 150 kg 912258 29,99

PRACTICAL ACCESSORIES



Steel step Load capacity up to 130 kg.
 Dimension opened: 62 x 40 x 23 cm
 Dimensions when closed: 48 x 30 x 8 cm. Weight: approx. 3.2 kg.
91184 27,99



Aluminium step Load capacity up to 150 kg. Dimension opened: 60 x 48 x 22 cm. Dimensions when closed: 48 x 37 x 7.5 cm. Weight: approx. 3.1 kg.
91190 62,90



Folding step Versatile and extremely resilient. With large step surface (37 x 31 cm) and non-slip surface. Height: 24 cm. When folded, it is only 5 cm high and therefore easy to store. Loadable up to 130 kg. Packing size 38 x 37 x 5 cm. Polypropylene. Weight approx. 2,1 kg
91185 14,90

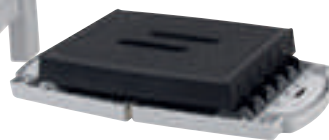

Plastic step Foldable. Load capacity up to 150 kg. Size: 42 x 28 x 26 cm
91194 16,99

Single and double step

- -Very sturdy design made of steel
- -Safe to step on due to rubber pads
- -Ideal for motorhomes and caravans

- ① **Carbest double step** Dimensions: W 380 x H 381 x D 634 mm . Weight: approx. 4.3 kg **91203 31,99**
- ② **Carbest step** Dimensions: W 380 x H 250 x D 390 mm . Weight: approx. 2.3 kg **912031 18,99**
- ③ **Carbest double step with handrail** Dimensions: W 640 x H 375 x D 430 mm **912026 37,90**
- ④ **Carbest step with handrail** Dimensions: W 360 x H 255 x D 440 mm **912025 29,90**
- ⑤ **Supports for steps** Dimensions: W 350 x D 230 mm. Weight: approx. 0.16 kg **912033 3,49**
- ⑥ **Sink-in protection 4 pcs.,** prevents sinking in on soft ground **912039 9,99**
- ⑦ **Set of 4 anti-sink guards,** universal for round and angular tubes **91176 6,95**



PRACTICAL-ACCESSORIES



EN 131-6 approved



Escali - Multifunctional ladder with max. 3.20 m length

- 11-stage, extended height max. 3.2 m!
- Ideal for loading the roof box or cleaning the caravan and motorhome
- Compact folding, fits easily into the boot or rear garage
- Can be loaded up to max. 150 kg, weight approx. 9.1 kg
- Working height approx. 4.2 m
- Approved according to EN 131-6

Safety note: The Escali multifunctional ladder must protrude 70 cm over the stop edge according to TÜV regulations!

Packing size: H approx. 77 cm, W approx 44/46 cm

440130 139,-



Compact aluminium folding ladder, max. 2.10 m length

- Material: Lightweight aluminium
- Loadable up to max. 150 kg

Aluminium folding ladder
With 6 steps. Dimensions when open: 210x45x6 cm, dimensions when closed: 210x6x6 cm. Weight approx. 3,8 kg

44005 89,90



12V Compressor Premium metal compressor for car tyres, floats and inflatable boats. Also suitable for motorhome tyres. 12V compressor, 360 W, pressure 10 bar/150PSI, 72 litres delivery volume per min. Integrated thermal protection switch and robust metal housing. With transport bag and valve attachments. With battery clamps for direct connection to the battery.

47408 89,-



Steel wheel claw - Anti-theft protection for cars and trailers

Steel wheel claw for wheels up to 26.5 cm wide. Delivery includes 2 keys. Dimensions: approx. 23 x 50 cm, weight: approx. 2,3 kg.

913401 37,99



Tent bellows tensioning rubber with quick-release clamp

Thanks to this practical rubber band, the bellows of your sleeping roof folds up perfectly. It is simply placed around the tent bellows and fixed with the quick release. Can be shortened individually.

442201 7,-

PRACTICAL HOUSEHOLD ACCESSORIES



12 V vacuum cleaner/cyclone system

No dust bag necessary. 12V/150 Watt. Incl. power supply, telescopic tube and 4 attachments: 360° round brush, upholstery nozzle, crevice nozzle and carpet brush. GS and CE approved. Weight approx. 1.7 kg.

804272 36,90



4m cable

Battery vacuum cleaner with cyclone system

- Usage time with full battery: 20 to 25 min.
- Generous accessories
- Also for home use

Cordless use possible, battery power 80 W. Usage time approx. 20-25 minutes. No dust bag necessary. Incl. charger with 12 V and 230 V adapter, telescopic tube and 4 attachments: 360° round brush, upholstery nozzle, crevice nozzle and carpet brush. GS and CE approved. Weight approx. 1.8 kg. Pack size 44.5 x 15 x 15 cm.

804273 59,99

① Camping washing machine 230 V / 170 W

- Replaces hand washing
- With spin function
- 2,5 kg capacity
- Compact and easy to store

Select washing time with timer. Drum and housing made of polypropylene. Incl. spin basket and water level indicator on the outside. Weight approx. 5 kg.

91906 74,90

② Folding washing machine 230 V

- For hygienically clean laundry on the go
- 2 kg capacity
- Foldable for small pack size

230 Volt, power 120 Watt. Dimensions approx. Ø 38 x H 44 (folded 25) cm. Weight approx. 4.5 kg.

919062 99,99



2 in 1 -

Battery vacuum cleaner Power Deluxe

- Slim and handy design, small pack size
- Powerful suction power (200W)
- Bagless stainless steel filter (capacity 200 ml)
- Can be used as a stick or hand vacuum cleaner
- Perfect for home and on the go

2 suction levels adjustable (runtime ECO max. 30 min, MAX max. 15 min), charging time: 4-5 hrs.

Scope of delivery: cordless vacuum cleaner, 12 V adapter, 230 V charging station, wand 60 cm, upholstery nozzle, floor nozzle, crevice nozzle, fold-out dust brush. Dimensions: L 45.5 x W 6.5 x H 10.5 cm, weight: vacuum approx. 0.8 kg, incl. accessories: approx. 1.6 kg.

804274 87,75



150 WATT

12 volt hair dryer

2-stage switch. Compactly stowable due to foldable handle, approx. dimensions when folded: L15 x H10 x D7 cm, when unfolded: L11 x H10 x D6 cm. Cable 130 cm, weight 145 g.

804190 13,70

CAB AND LIVING COMFORT



Seat cover for Fiat Ducato

- Premium quality in imitation leather, colour anthracite
- For driver and passenger seat

Seat cover for Fiat Ducato from year 2007, with foam headrest cap **943562 99,99**

Seat cover for Fiat Ducato from 2014 onwards **943563 99,99**

Armrest cover from year 2007, 1 pair **943564 29,99**



Cab carpet for VW T6 Multivan

- 1-piece carpet for driver's cab
- With binding tape
- Luxuryversion (Tuftvelour 920g/m²) Colour black **515821 159,-**



Utensilo with 2 pockets

- Attachment of the holding mat with metal eyelets on the back of the driver's seat
- Pockets are firmly attached to the mat and can be opened via Velcro fastener

Consists of: 1 x bag (dimensions: 36 x 20 x 5cm) and 1 x bag (dimensions: 28x48x9cm) **919164 149,-**



Utensilo with 3 pockets

- Attachment of the mat with metal eyelets on the back of the passenger seat
- Pockets are firmly attached to the mat and can be opened via Velcro fastener

Consists of: 1 x bag (dimensions: 36 x 20 x 5cm) and 2 x bags (dimensions: 45 x 25 x 6cm) **919165 189,-**



Organizer Deluxe

- 4 pockets
- 1 pocket for magazines, maps etc.

Noble organizer to fasten with press studs (included). Dimensions: H 58 x W 24 cm.

Imitation leather in grey 919168 44,90
Microfibre in beige 919170 44,90

Simultaneous charging of smartphone and tablet



2-way USB distributor

USB charging plug with 2 x 2.4 A, also suitable for charging tablets **813031 7,70**



Universal tablet / mobile phone holder For device widths of approx. 10 - 17.7 cm, 360° rotatable, for headrest, bicycle, etc. **462381 29,99**



Tested in 10.000 km endurance test

Universal navigation and mobile phone holder

With suction cup attachment, 360° rotatable, retaining clips open up to 105 mm wide. Material: ABS+PU, black, dimensions: 12x10x7,5 cm. (Delivery without smartphone). **46238 5,99**

X-TREM® VEHICLE INSULATION

X-Trem® Stretch Carpet Felt

- 4-way / superstretch (4-way superstretch)
- Due to the special stretchability even curves like wheel arches are no problem
- Suitable for all surfaces (wood, plastic, metal and also on insulation)
- Thickness approx. 4.6 mm
- Weight approx. 390 g/sqm
- In 5 different colours
- Material: 100% polyester

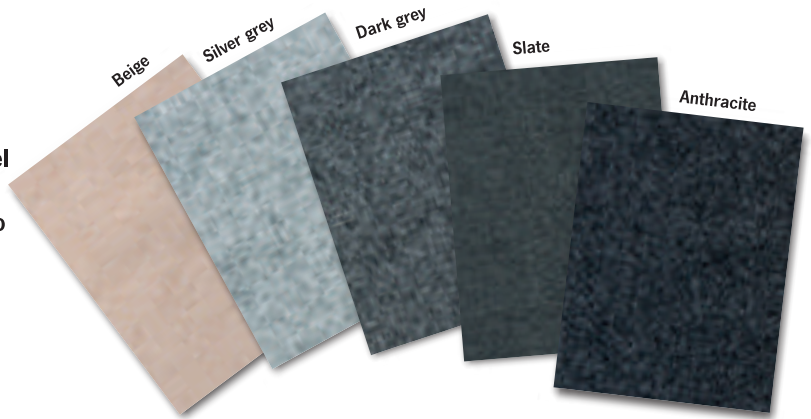
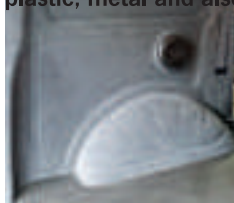

Color	Cut to size W 2 x L 2 m (4m ²)			Cut to size W 2 x L 5 m (10m ²)			Roll W 2 x L 30 m (60m ²)		
Beige	500891	75,60	GP* 18,90/sqm	500890	139,-	GP* 13,90/sqm	50089	559,-	GP* 9,31/sqm
Silver grey	500831	75,60	GP* 18,90/sqm	500830	139,-	GP* 13,90/sqm	50083	559,-	GP* 9,31/sqm
Dark grey	500841	75,60	GP* 18,90/sqm	500840	139,-	GP* 13,90/sqm	50084	559,-	GP* 9,31/sqm
Slate	500851	75,60	GP* 18,90/sqm	500850	139,-	GP* 13,90/sqm	50085	559,-	GP* 9,31/sqm
Anthracite	500881	75,60	GP* 18,90/sqm	500880	139,-	GP* 13,90/sqm	50088	559,-	GP* 9,31/sqm

Quilted interior trim for VW T5/T6 buses without windows

- Cosy ambience in VW T6 without windows
- Chic imitation leather look with quilting
- Mounting material included

Easy to attach with dowels in the existing holes in VW T5/T6 (without glazing) or with Velcro. Fixing material included. The material is colour-coordinated with the VW interior colours.

① 1x panel for sliding door	32000	139,-
② 1x panels for side opposite sliding door	32001	144,-
③ 1x panel for rear right side window	32002	139,-
④ 1x panel for rear left side window	32003	139,-

FITTING:

Imitation leather, grained, for other interior trim (e.g. spars) Light grey, laminated with 3 mm foam
 510211 41,90
 Light grey, unlaminated
 510211-1 29,99

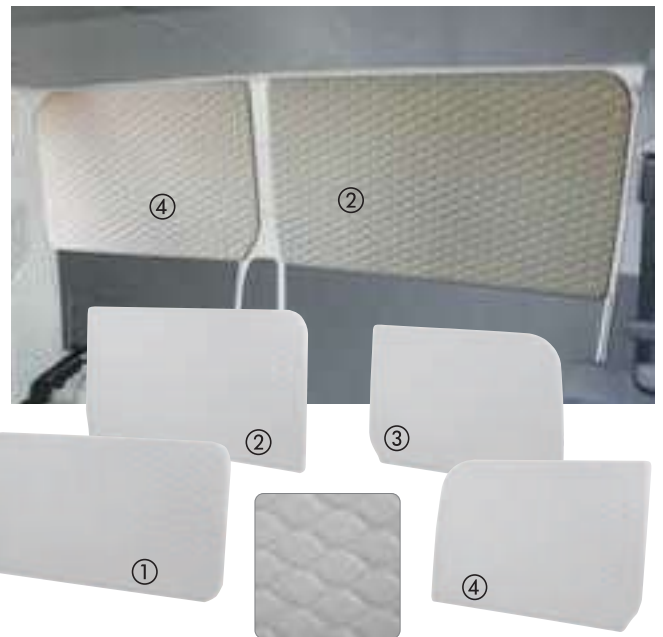

X-Trem® Noise Regulator Self-adhesive noise & sound insulation

- Excellent noise control and sound insulation
- Self-adhesive, with strong surface adhesion
- Alu-butyl, 2 mm thick, aluminium coated, odourless
- Without bitumen, not mixed with petroleum or asphalt
- Heat reflecting

Temperature resistant from -30°C to +80°C
 Adhesive layer covered with protective film

100 x 50 cm	GP 25,80/1 sqm	50098	12,90
500 x 40 cm	GP 16,50/1 sqm	50099	37,90

Please wear gloves to protect against the sharp-edged film when applying.

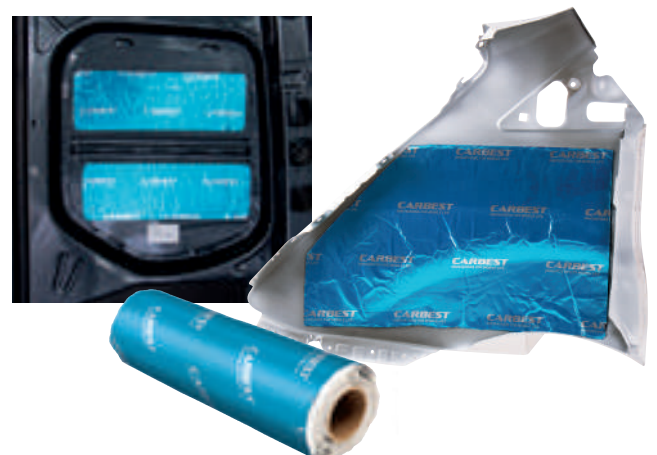

COMPLETE ROLLER DOOR SET

- For building a roller shutter door that opens up
- For maximum door size of 100 cm height and 60 cm width
- Enables opening even in confined spaces
- Complete with cut-to-size roller shutter, rails and panel

The guide rails, roller shutter mat and retractable panel can be cut to the required door size and cabinet depth. Material: plastic.

Roller shutterdoor set consisting of:

- 1 x Roller shutter mat with handle strip, H 100 x W 60 cm
- 4 x Guide rails for screwing on, L 100 cm
- 4 x Guide bends 90° for screwing on
- 1 x Retractable cover, L 100 cm

Colour silver	53044	83,99
Colour Beige, structured	53045	83,99

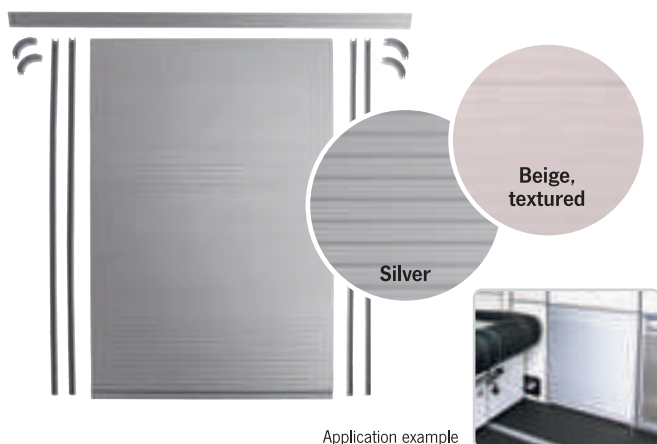

Application example

ROLLER DOOR FOR BATHROOMS AND TOILETS

Silver-coloured plastic roller shutter door with handle strip at both ends

Height max. 198 cm, width max. 100 cm, each can be shortened. Slat width approx. 32 mm

Scope of delivery:

- Slat door, floor glides, 2 x 90° guide rails (100/20 cm) each for top and bottom, 2 m magnetic tape, assembly instructions

Roller door H198 x W100 cm,	53046	249,90
-----------------------------	-------	--------

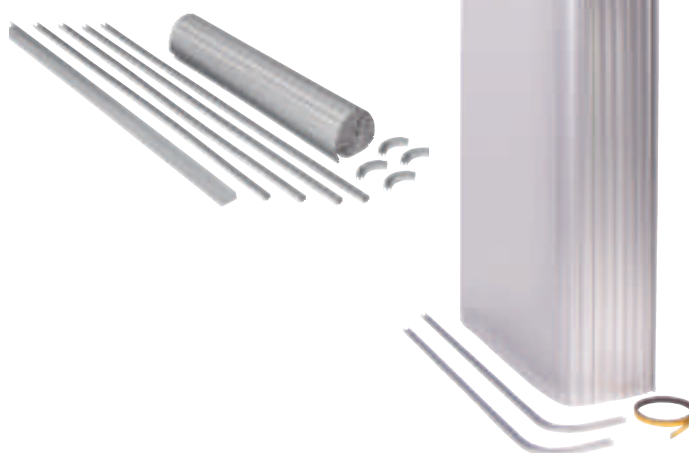

PRESSURIZED WATER PUMPS & DIVE PUMPS



① 3-chamber pressure water pump - 7 l/min, 1.4 bar

Self-priming. Connection via 1/2" external thread incl. filter and hose adapter. Approx. dimensions: L 203 x W 130 x H 123 mm, 12 V, 3.0 A (max. 6.0 A)

62055 89,90

② 3-chamber pressure water pump - 10 l/min, 2.8 bar

Self-priming. Connection via 1/2" external thread incl. filter and hose adapter. Approx. dimensions: L 203 x W 130 x H 123 mm, 12 V, 3.5 A (max. 7.5 A)

62056 94,90

③ 4-chamber pressure water pump - 11.3 l/min, 3.8 bar

Self-priming. Connection via 1/2" external thread incl. filter and hose adapter. Approx. dimensions: L 203 x W 130 x H 111 mm, 12 V, 3.5 A (max. 7.5 A)

620560 109,-

Submersible pumps

- Pipe socket connection for hoses with Ø 10-12 mm
 - Connection with hose clamp to any hose with suitable diameter possible
 - Suitable for short dry runs
 - Small diameter - Suitable for small canister openings
- Not suitable for drinking water

No.	Designation	l/m	bar	Watt	Ø Pump	Item no	Price
④	Submersible pump 10 l	10	1,5	40	38 mm	62130	12,99
⑤	Submersible pump 15 l	15	1,5	50	49 mm	62131	14,20
⑥	Submersible pump 20 l	20	1,8	80	52 mm	62132	24,90

POWERFUL 12V STAINLESS STEEL EXHAUST HOOD

Stainless steel housing, with lighting 2 x 1.5 W LED (2 x 80 lumen), Warm white (3000 Kelvin), suction power 98^{m3/h}, 12 V, only for Motorhomes and caravans. Dimensions: W 40 x D 27 x H 5 cm. Weight 1,8 kg

31852 129,-



PROTECT YOUR VEHICLE FROM DAMAGE

Load sill protection

For Citroen Jumpy from 2017, Citroen Spacetourer 2017, Toyota Verso III from 2017, Toyota Proace III from 2017, Opel Zafira Life from 2019, Opel Vivaro from 2019, Peugeot Expert from 2017, Peugeot Traveller from 2017

Brushed stainless steel, short wheelbase ①	45830	75,90
Stainless steel black brushed, short wheelbase	45831	89,90
Stainless steel brushed, long wheel	45832	75,90

For MB Vito W447 2014

Stainless steel brushed	45833	52,90
Stainless steel black brushed	45834	64,90

For MB Sprinter 2006-2018, VW Crafter 2006-2017 Van

Stainless steel brushed	45835	52,90
Stainless steel black	45836	82,90

For MB Sprinter from 2018

Stainless steel brushed ②	45837	59,90
Stainless steel black	45838	75,90

For Fiat Talento as of 2016, Opel Vivaro III 2014- 2019, Renault Traffic III as of 2014

Stainless steel brushed	45839	56,90
Stainless steel black	45840	67,90

For VW T6 Transporter, Caravelle & Multivan as of 2015

Stainless steel brushed (Single Door) ③	45841	56,90
Stainless steel black brushed (Single Door) ④	45842	67,90

For VW T5 Transporter, Caravelle & Multivan 2003-2015 Van, VW T6 Transporter as of 2015 Van

Stainless steel brushed	45843	49,90
Stainless steel black ⑤	45844	59,90
Stainless steel & carbon foil ⑥	45845	41,90

For VW Crafter from 2017 Van

Stainless steel brushed	45846	79,90
-------------------------	-------	-------



Mirror protector set (left and right)

For Fiat Ducato / Citroën Jumper / Peugeot Boxer from 2006 (X250 and X290)

• Material plastic, high gloss painted

Protects the mirror from damage or hides existing damage. Long version for semi-integrated and alcoves, short version for campers. Available in white, chrome and black.

① White:	Short version	45815	69,99
	Long version	45816	69,99
② Chrome:	Short version	45811	79,99
	Long version	45812	79,99
③ Black:	Short version	45813	69,99
	Long version	45814	69,99



Mirror caps

For Citroën Jumpy from 2017, Citroën Spacetourer 2017, Citroën Berlingo III Panel Van from 2019, Citroën Berlingo III Passenger Van from 2019, Opel Vivaro from 2019, Peugeot Expert from 2017, Peugeot Traveller from 2017, Toyota Proace III from 2017. Material: ABS. Colour: Chrome 45850 59,90

CARBEST

INNOVATIONS FOR MOBILE LIFE

95464



4 043729 156975

REIMO REISEMOBIL-CENTER GMBH
BOSCHRING 10 - 63329 EGELSBACH - GERMANY - www.reimo.com

CARBEST IS A REGISTERED TRADEMARK OF REIMO REISEMOBIL-CENTER GMBH.
Copyright: Reimo Reisemobil-Center GmbH. Delivery subject to change. All products without decoration. Misprints, errors and technical errors and technical changes/developments reserved. All data without guarantee. The permissible tolerance for technical is +/- 5%. Illustrations partly show extras and decorations which are not included in the scope of delivery. All rights reserved reserved. Reprinting and use in electronic media, also in extracts, only with the express permission of of Reimo Reisemobil-Center GmbH, Egelsbach. Status March 2021.